

# Frese da taglio

Routers

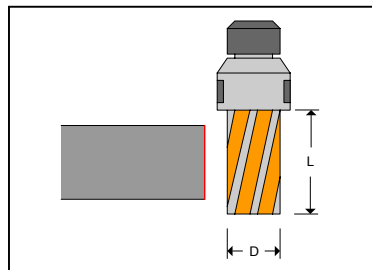

**N I C O L A I**  
D I A M A N T  
diamond tools



### A segmenti per granito - Segmented for granite

Codice Code	D	L	A	Lastra Slab	Segmenti Segments	Lega Bond	
AFS90005		30		2 cm.	Z5	FB2	
AFS90015		40		3 cm.	Z5	FB2	
AFS90025	23	50	1/2 gas	4 cm.	Z5	FB2	
AFS90035		60		5 cm.	Z5	FB2	
AFS90040		70		6 cm.	Z5	FB2	

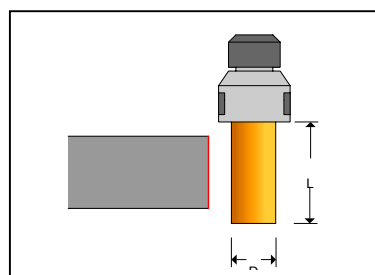

### Elettrolitiche per marmo - Electroplated for marble

Codice Code	D	L	A	Lastra Slab	
AFE80005		30		2 cm.	
AFE80010	16	40	1/2 gas	3 cm.	
AFE80015		50		4 cm.	
AFE80027		60		5 cm.	
AFE80030	20	70	1/2 gas	6 cm.	
AFE80037		100		9 cm.	
AFE80045		80		7 cm.	
AFE80050	23	90	1/2 gas	8 cm.	
AFE80055		100		9 cm.	

**Frese per taglio a passate**  
Crown mill for step cutting



**N I C O L A I**  
**D I A M A N T**  
diamond tools

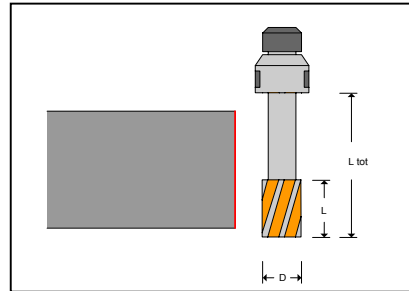

**A segmenti per granito - Segmented for granite**

Codice Code	D	L	L tot	A	Lega Bond	Segmenti Segments
AFS90065		40	85		FB2	Z7
AFS90066	28		105	1/2 gas	FB2	Z7
AFS90067			125		FB2	Z7

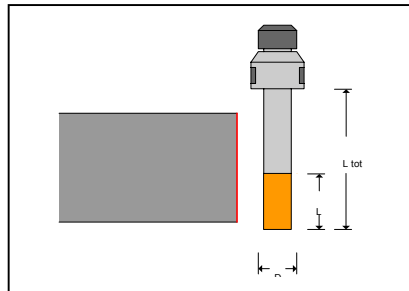

**Elettrolitiche per marmo - Electroplated for marble**

Codici Code	D	L	L tot	A
AFE81005			85	
AFE81010			105	
AFE81015	23	40	125	1/2 gas
AFE81020			155	
AFE81030			205	

# Mole per taglio a passate

Wheels for step cutting



**N I C O L A I**  
**D I A M A N T**  
 diamond tools

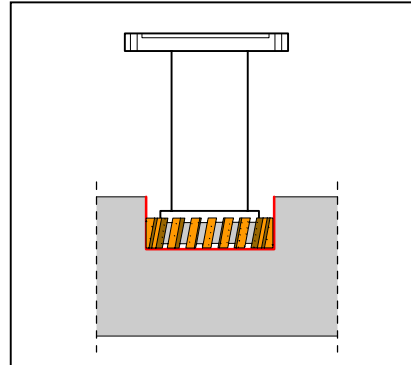

Codice Code	D	L	F		
AMS00020	50	20	SEG	GR	Ø10+2M5
AME00020			ELE	MR	

## Prolunghe / Coni - Extensions / Cones

Codici Code	A		A'	
AZT2354A		138		
AZT2353A	PROLUNGA / Extension	190	FLANGE	Ø10+2M5
AZT1381A		229		
	CONE ISO40		TECNO	
			BREMBANA	FLANGE
			INTERMAC	
			BRETON	

**Frese a corona taglio a passate**  
Crown mills for step cutting



**N I C O L A I**  
**D I A M A N T**  
diamond tools

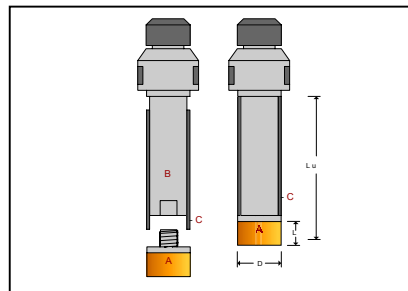
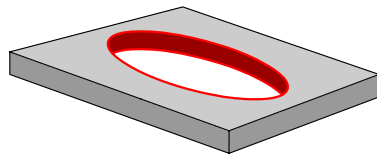

**Testine diamantate - Diamond tips**

Codice Code	D	L	Materiale Material	Materiale Material	A	A'
AFS40010	20	10	FC	GR	M10	
AFS40052		15				
AFE41010	20	10	ELE	MR	M10	

**Accessori - Accessories**

AZT1518B	B	corpo-body			1/2GAS	M10
AZT15181	C	boccola-Rotating sleeve				

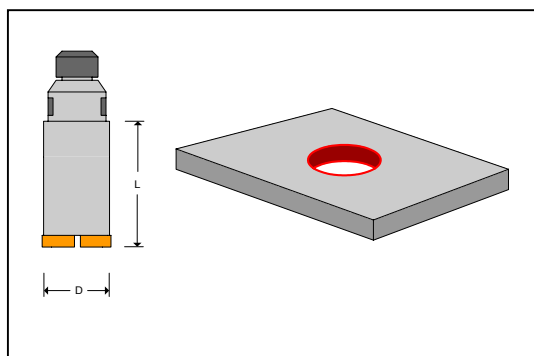

**A segmenti per granito e marmo - Segmented for granite**

Codice Code	D	A	LU
APS1B020	20		
APS1B025	25		
APS1B030	30		
APS1B032	32	1/2 gas	70
APS1B035	35		
APS1B040	40		
APS1B050	50		

**Prolunghe - Extensions**

Codice Code	Descrizione Description	LxD	A'	A''
AZT1014A	PROLUNGA Extension	110x50	Flang.	Flang.
AZT0584A		138x45	Flang.	Flang.
AZT0734A		212x45	Flang.	Flang.

**Attacchi - Attachments**

Codice Code	Descrizione Description	A'	A''
AZT0566A	SCASSO	1/2GAS	Ø50+3FM6/Ø63
AZT0593A	TERZAGO	M30	TERZAGO
AZT0743A	MAGNETICO		MAGNETICO

**Coni - Cones**

Codice Code	Descrizione Description	A'	A''
AZC1067A	CMS-TECNO SCASSO CORTO - short	ISO40	Ø50+6FM6/Ø63
AZC1068A			Ø50+6FM6/Ø63
AZC0556A	CMS-BREMB SCASSO CORTO - short	ISO40	Ø50+6FM6/Ø63
AZC0557A			Ø50+6FM6/Ø63

## Fresette cilindriche

Cylindrical mills



N I C O L A I  
D I A M A N T  
diamond tools

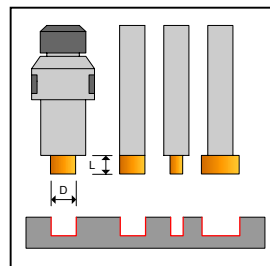

### Elettrolitiche per incisione marmo - Electroplated for engraving marble

Con foro per passaggio acqua - With hole for internal water passage

Codice	D	L	A	Grana	
Code				Grit	
AFE10030	8	20			
AFE10050	8	30			
AFE10035	10	20			
AFE10055	10	30	1/2GAS	rossa - Coars	
AFE10040	12	20			
AFE10060	12	30			
AFE10045	15	20			
AFE10065	15	30			
AFE00060	8	12			
AFE00065	10	12	Ø10	rossa - Coarse	
AFE00070	12	12			
AFE00075	15	12			

Grana-Grit : Grossa-coarse (D427), Grossa-coarse \* (D501T)

### Elettrolitiche per incisione marmo - Electroplated for engraving marble

Senza foro - Without hole

Codice	D	L	A	Grana	
Code				Grit	
AFE00005	2	10			
AFE00010	3	10			
AFE00015	4	15	Ø6	Grossa Coarse	
AFE00020	5	15			
AFE00025	6	15			
AFE00080	3/5	15			
AFE00030	4	12			
AFE00035	5	12	Ø10	Grossa Coarse *	
AFE00040	6	12			

Grana-Grit : Grossa-coarse (D427), Grossa-coarse \* (D501T)

### Attacchi - Attachment

Codice	Descrizione	A	A	
Code	Description			
AZT0571A	ATTACCO	1/2GAS	ERG20	
AZZ00012	PINZA ELASTICA	ERG20	Ø6	
AZZ00014	PINZA ELASTICA	ERG20	Ø10	
AZZ0890A	GHIERA DI SERRAG.	ERG20		

# Fresette cilindriche

Cylindrical mills



N I C O L A I  
D I A M A N T  
diamond tools

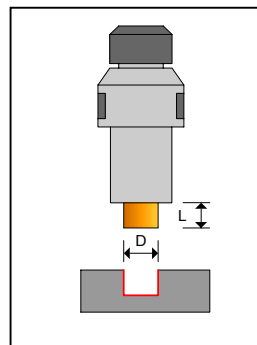

## CILINDRICHE per intarsio granito - Cylindrical for engraving granite

Con foro passaggio acqua - With central hole for water passage

Codice	D	L	A	Grana
Code	Grit			
AFF10005	Ø8	12		
AFF10010	Ø10	12		
AFF10015	Ø12	12	1/2GAS	rossa - Coars
AFF10020	Ø15	12		
AFF10025	Ø20	12		

Grane-Grit : Grossa-coarse (P1)

**Frese coniche per scrittura**  
Conic mills for writing



**N I C O L A I**  
**D I A M A N T**  
diamond tools

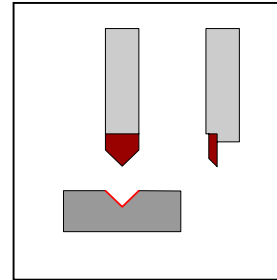

**Widia per marmo - Widia tool for marble**

Codice	D	L	Conicità	A
Code	Degrees			
AFW60010	10	10	90°	CIL Ø10
AFW60020	15	10		

**PCD per granito - PCD tool for granite**

Codice	D	L	Conicità	A
Code	Degrees			
AFW80005			90°	
AFW80010	10	10	60°	CIL Ø10

**Attacchi - Attachment**

Codice	Descrizione	A'	A''
Code	Description		
AZT0571A	ATTACCO	1/2GAS	ERG20
AZZ00014	PINZA ELASTICA	ERG20	Ø10
AZZ0890A	GHIERA DI SERRAG.	ERG20	

**Frese coniche per sgrossatura**  
*Conic mills for roughing*



**N I C O L A I**  
**D I A M A N T**  
*diamond tools*

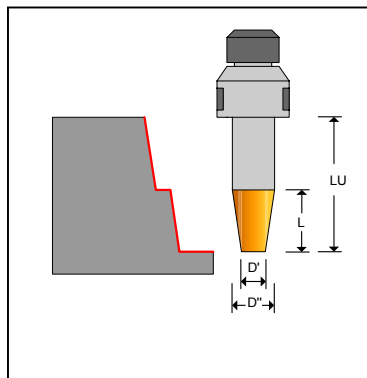

**Elettrolitiche per marmo - Electroplated for marble**

Codice	D'/D''	L	A	Grana
Code				Grit
AFE30005	8/14	40/40	1/2GAS	Grossa Coarse
AFE30010	14/20	40/40		
AFE30015	14/20	40/50		
AFE30020	14/20	14/100		

Grana-Grit: Grossa-Coarse (D602),

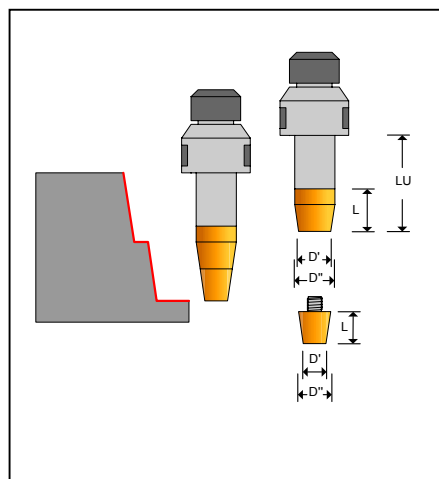

**Elettrolitiche per marmo - Electroplated for marble**

Con testina sostituibile - *With exchangeble head*

Codice	D'/D''	L	Tipo	A	Grana
Code			Type		Grit
AFE40020		20/20	Base	1/2GAS	Grossa Coarse
AFE40030	18/20 *	20/30			
AFE40060		20/60			
AFE42001	14/18 **	0/25	Testina-head	M8 MALE	

Grana-Grit: Grossa-Coarse (D602)

**Frese coniche per finitura**  
*Conic mills for finishing*



**N I C O L A I**  
**D I A M A N T**  
*diamond tools*

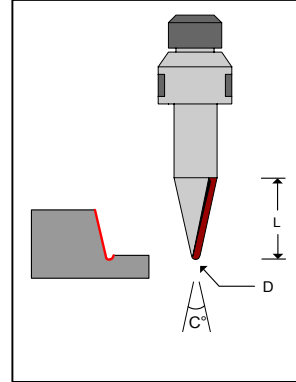

**Widia per marmo - Widia tool for marble**

Codice <i>Code</i>	D	L	Conicità <i>Degrees</i>	A
AFW50005	3	30	15°	1/2GAS
AFW50010	5	30		
AFW50015	5	50		
AFW50020	8	30		
AFW50025	8	50		
AFW50030	20	30		
AFW50035	20	50		

**PCD per Granito e marmo - PCD tool for granite and marble**

Codice <i>Code</i>	D	L	Conicità <i>Degrees</i>	A
AFW90005	3	15	15°	1/2GAS
	5	15		

# Frese a testa sferica

Ball-head mills



N I C O L A I  
D I A M A N T  
diamond tools

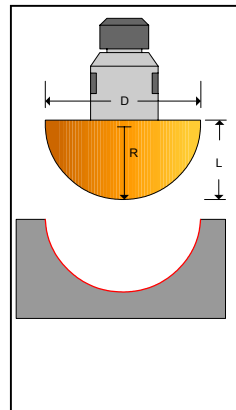

## Elettrolitiche per marmo - Electroplated for marble

Codice	D	R	L	A	Grana
Code					Grit
AFE60005	30	15	20	1/2 gas	1
AFE60010					2
AFE60015	40	20	25		1
AFE60020					2
AFE60025	50	25	30		1
AFE60030					2
AFE60035	60	30	35		1
AFE60040					2

Grana-Grit: 1 (D602); 2 (D107)

## A segmenti per granito - Segmented for granite

Codice	D	R	L	A	Grana
Code					Grit
AFS60005	30	15	20	1/2 gas	1
AFS60010					3
AFS60015	40	20	25		1
AFS60020					3
AFS60025	50	25	30		1
AFS60030					3
AFS60035	60	30	35		1
AFS60040					3

Grana-Grit: 1 Grossa-coarse; 3 Media-medium

## Prolunghe - Extensions

Codice	Descrizione	L	Ø	A'	A''	A'''
Code	Description					
AZT0587A		100	30			
AZT0588A	PROLUNGA	150	30	Flangiato Flange	1/2G fem	
AZT0589A	Extension	200	40			
AZT0590A		250	40			

# Frese testa raggiata

Round-head tools



**N I C O L A I**  
D I A M A N T  
diamond tools

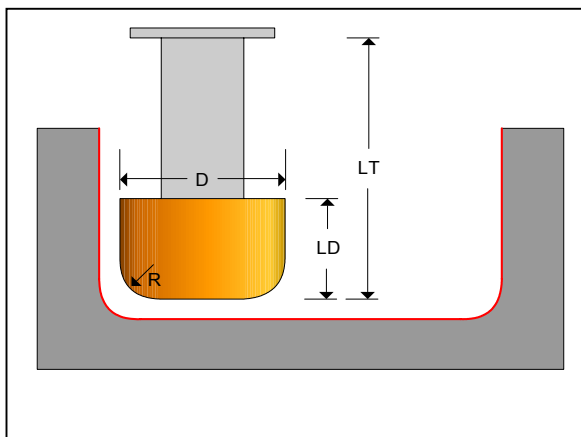

## Elettrolitiche con testa raggiata - Electroplated with rounded head

Attacco flangiato - Flange connection

Codice Code	D	R	LD	LT	Grana Grit		
AFE70003	50	20	50	120	1		
AFE70004					2		
AFE70011			50	150	1		
AFE70012					2		
AFE70005			50	177	1		
AFE70010					2		
AFE70013			50	225	1		
AFE70014					2		
AFE70033			85	20	50	120	1
AFE70034							2
AFE70031	50	150			1		
AFE70032					2		
AFE70015	50	177			1		
AFE70020					2		
AFE70025	50	225			1		
AFE70030					2		

Grane-Grit: 1 Grossa-coarse (D602); 2 Media-medium (D107)

## A segmenti con testa raggiata - Segmented with rounded head

Attacco flangiato - Flange connection

Codice Code	D	R	LD	LT	Grana Grit
AFS70005	50	20	50	177	1
AFS70010					3
AFS70015			50	225	1
AFS70020					3
AFS70025	85	20	50	175	1
AFS70030					3

Grane-Grit: 1 Grossa-coarse; 3 Media-medium

## Prolunghe - Extensions

Codice Code	Descrizione Description	L	D	A'	A''
AZT1014A	PROLUNGA Extension	110	50	Flang.	Flang.
AZT0584A		138	45	Flang.	Flang.
AZT0734A		212	45	Flang.	Flang.

**Set utensili per lavelli in marmo**  
*Set of tools for marble sinks*



**N I C O L A I**  
**D I A M A N T**  
**diamond tools**

Utensili elettroliti per vasca profonda 170 mm.

Codice	Descrizione	D	R	LD	LT	A	Grana	
Code	Description						Grit	
APE43049	Foretto <i>Core drill</i>	50			180	Flange	1	
AME00030	Mola da scasso <i>Recess wheel</i>	85		20		Flange	1	
AFE70015	Fresa testa raggiata <i>Round-head tool</i>	85	r.20	50	177	Flange	1	
AFE70020	Fresa testa raggiata <i>Round-head tool</i>	85	r.20	50	177	Flange	2	
AZT0589A	Prolunga mola	40			170	Flange		

# Dischi da taglio

Cutting blades



N I C O L A I  
D I A M A N T  
diamond tools

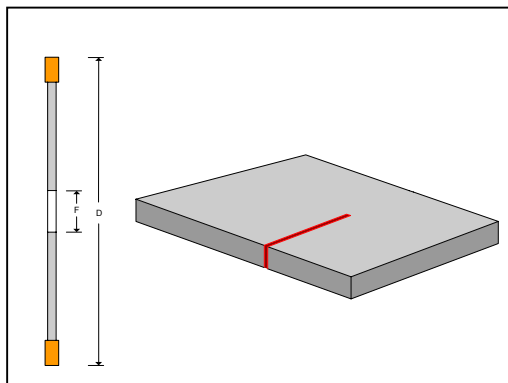

## Per taglio rettilineo - For straight cut

Codice	D	Materiale	Segmenti	Anima	Foro
Code		Material	Segments	Core	Bore
ADS01011	210	MR	Z24 20x3.6x6	Silent	Ø50
ADS00013		GR	Z24 20x3.6x6		

MR: Marmo-marble; GR: Granito-granite  
Lega-bond: MR (MR70), GR (G30I)

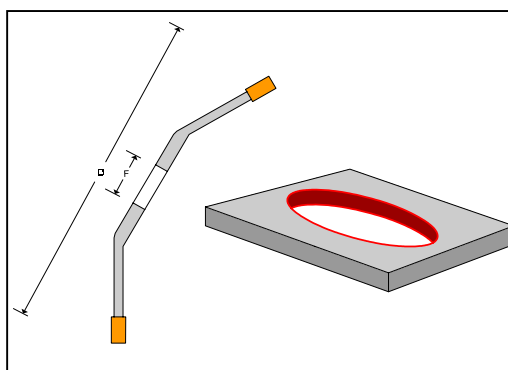

## Concavo per taglio in curva - Concave for curvilinear cut

Codice	D	Materiale	Segmenti	Anima	Foro
Code		Material	Segments	Core	Bore
ADS10013	180	GR & MR	Z18+6RFC	Normal	Ø50+4D6/63
ADS10010			Z18		
ADS10011	160	GR & MR	Z16	Normal	Ø50+4D6/63

Lega-bond: Gr & Mr (N11S)

	180	MR	ELE	Normal	Ø50+4D6/63
	160				

Elettrolitici per marmo - electroplated for marble

# Utensili per gocciolatoio

Tools for drainage grooves



N I C O L A I  
D I A M A N T  
diamond tools

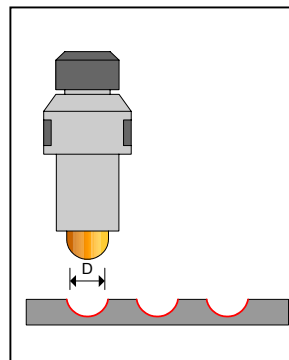

## FRESETTE A TESTA SFERICA - Spheric head mills

Con foro passaggio acqua - With central hole for water passage

Codice	D	Raggio	A	Grana
Code		Radius		Grit
AFF20005	10	5	1/2GAS	1
AFF20010				3
AFF20011				4
AFF20012				5
AFF20015	15	7,5	1/2GAS	1
AFF20020				3
AFF20021				4
AFF20022				5
AFF30025	20	10	1/2GAS	1
AFF30030				3
AFF30031				4
AFF30032				5

Grane-Grit : 1 Grossa-coarse; 3 Media-medium; 4 Fine-fine; 5 Extrafine-extrafine

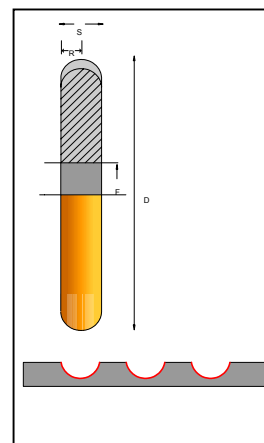

## DISCHI CON PROFILO RAGGIATO - Rounded shape blades

Codice	Tipo	Dimensioni	Raggio	Foro	Grana
Code	Type	Dimension	Radius	Bore	Grit
ASS02505	SEG	200x10	5	50	1
ASF02520	FC				3
ASF02525	FC				4
ASR02590	ABR				LUX
ASS02705	SEG	200x15	5	50	1
ASS02720	FC				3
ASS02725	FC				4
ASR02790	ABR				LUX

## Elettrolitici per marmo - Electroplated for marble

ASS02505	ELE	200x10	5	50	1
ASF02520	ELE	200x15	7,5	50	1

Grane-Grit : 1 Grossa-coarse; 3 Media-medium; 4 Fine-fine



## Mole per piani cucina

Wheels for kitchen tops

### Set con bordino a 30° - Set for 30° edge

Codice	Tipo	Lavoro	Dimensione	Grana	Fori
Code	Type	Job	Dimension	Grit	Holes
AMS00030	SEG	Scasso	Ø85x20	1	Ø50-3+3FT
ASS30105	SEG			1	
ASF30115	FC	30°		3	Ø50+3FT
ASF30120	FC			4	
ASR30125				220	
ASR30130	ABR	30°		400	Terzago
ASR30135				1000	
CLR02010				100	
CLR02015				200	
CLR02020				500	
CLR02025	RESIN	Lucid. Piano Flat surface	Ø 100	1000	Magnetico
CLR02030				2000	
CLR02035				3000	
CLR02045				BUFF	

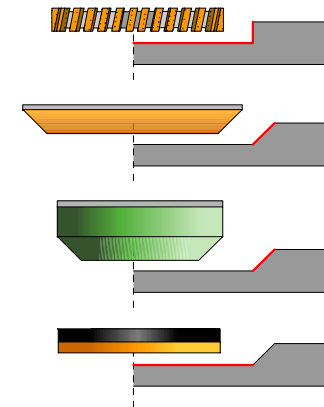

Grana-grit : 1 Grossa-coarse ; 3 Media-medium ; 4 Fine-fine

### Prolunghe - Extensions

Codice	Descrizione	LxD	A'	A"
Code	Description			
AZT1014A	PROLUNGA	110x50	Flang.	Flang.
AZT0584A	Extension	138x45	Flang.	Flang.
AZT0734A		212x45	Flang.	Flang.

### Attacchi - Attachments

Codice	Descrizione	A'	A"
Code	Description		
AZT0566A	SCASSO	1/2GAS	Ø50+3FM6/Ø63
AZT0593A	TERZAGO	M30	TERZAGO
AZT0593L	LEVA PER TERZAGO		
AZT0743A	MAGNETICO		MAGNETICO

### Coni - Cones

Codice	Descrizione	A'	A"
Code	Description		
AZC1067A	CMS-TECNO SCASSO CORTO - short	ISO40	Ø50+6FM6/Ø6
AZC1068A	SCASSO LUNGO - long		
AZC0556A	CMS-BREMB SCASSO CORTO - short	ISO40	Ø50+6FM6/Ø6
AZC0557A	SCASSO LUNGO - long		



## Mole per piani cucina

Wheels for kitchen tops

### Set con bordino a 45° - Set for 45° edge

Codice	Tipo	Lavoro	Dimensione	Grana	Fori
Code	Type	Job	Dimension	Grit	Holes
AMS00030	SEG	Scasso	Ø85x20	1	Ø50-3+3FT
ASS30205	SEG			1	
ASF30215	FC	45°		3	Ø50+3FT
ASF30220	FC			4	
ASR30225				220	
ASR30230	ABR	45°		400	Terzago
ASR30235				1000	
CLR02010				100	
CLR02015				200	
CLR02020				500	
CLR02025	RESIN	Lucid. Piano Flat surface	Ø 100	1000	Magnetico
CLR02030				2000	
CLR02035				3000	
CLR02045				BUFF	

Grana-grit : 1 Grossa-coarse ; 3 Media-medium ; 4 Fine-fine

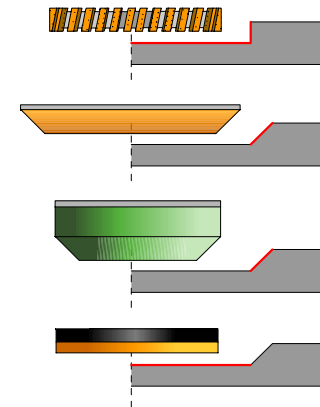

### Prolunghe - Extensions

Codice	Descrizione	LxD	A'	A''
Code	Description			
AZT1014A	PROLUNGA	110x50	Flang.	Flang.
AZT0584A	Extension	138x45	Flang.	Flang.
AZT0734A		212x45	Flang.	Flang.

### Attacchi - Attachments

Codice	Descrizione	A'	A''
Code	Description		
AZT0566A	SCASSO	1/2GAS	Ø50+3FM6/Ø63
AZT0593A	TERZAGO	M30	TERZAGO
AZT0593L	LEVA PER TERZAGO		
AZT0743A	MAGNETICO		MAGNETICO

### Coni - Cones

Codice	Descrizione	A'	A''
Code	Description		
AZC1067A	CMS-TECNO SCASSO CORTO - short	ISO40	Ø50+6FM6/Ø6
AZC1068A	SCASSO LUNGO - long		
AZC0556A	CMS-BREMB SCASSO CORTO - short	ISO40	Ø50+6FM6/Ø6
AZC0557A	SCASSO LUNGO - long		



## Mole per piani cucina

Wheels for kitchen tops

### Set con bordino a 60° - Set for 60° edge

Codice	Tipo	Lavoro	Dimensione	Grana	Fori
Code	Type	Job	Dimension	Grit	Holes
AMS00030	SEG	Scasso	Ø85x20	1	Ø50-3+3FT
ASS30005	SEG			1	
ASF30015	FC	60°		3	Ø50+3FT
ASF30020	FC			4	
ASR30025				220	
ASR30030	ABR	60°		400	Terzago
ASR30035				1000	
CLR02010				100	
CLR02015				200	
CLR02020				500	
CLR02025	RESIN	Lucid. Piano Flat surface	Ø 100	1000	Magnetico
CLR02030				2000	
CLR02035				3000	
CLR02045				BUFF	

Grana-grit : 1 Grossa-coarse ; 3 Media-medium ; 4 Fine-fine

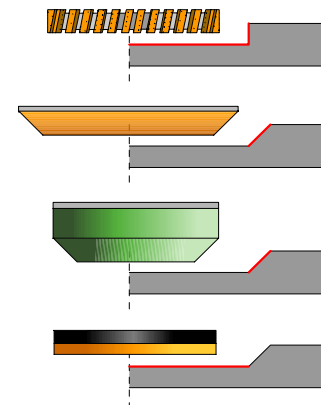

### Prolunghe - Extensions

Codice	Descrizione	LxD	A'	A''
Code	Description			
AZT1014A	PROLUNGA	110x50	Flang.	Flang.
AZT0584A	Extension	138x45	Flang.	Flang.
AZT0734A		212x45	Flang.	Flang.

### Attacchi - Attachments

Codice	Descrizione	A'	A''
Code	Description		
AZT0566A	SCASSO	1/2GAS	Ø50+3FM6/Ø63
AZT0593A	TERZAGO	M30	TERZAGO
AZT0593L	LEVA PER TERZAGO		
AZT0743A	MAGNETICO		MAGNETICO

### Coni - Cones

Codice	Descrizione	A'	A''
Code	Description		
AZC1067A	CMS-TECNO SCASSO CORTO - short	ISO40	Ø50+6FM6/Ø6
AZC1068A	SCASSO LUNGO - long		
AZC0556A	CMS-BREMB SCASSO CORTO - short	ISO40	Ø50+6FM6/Ø6
AZC0557A	SCASSO LUNGO - long		

# Mole di sbazzatura

Preshaping wheels

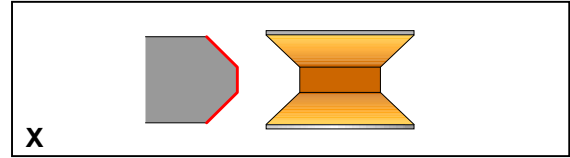

**Profilo a "X" - "X" shape**

		Codice	Dm	De	Lastra	Profili utiliz.
		Code	mD	oD	Slab	Avail. for shapes
Foro / Bore av.	35-30-22	ASS00005		74	20	
		ASS00010	60	85	30	I, T, V, 4
		ASS00015		93	40	

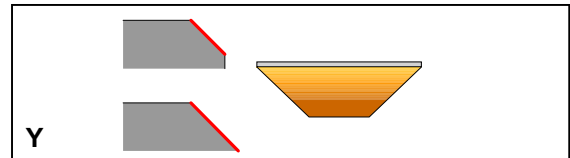

**Profilo a "Y" - "Y" shape**

		Codice	Dm	De	Lastra	Profili utiliz.
		Code	mD	oD	Slab	Avail. for shapes
Foro / Bore av.	35-30-22	ASS00035		107	20	
		ASS00040	60	126	30	A, B, D, E, F,
		ASS00045		146	40	H, L, O, 3

Dm - mD : Diametro minimo - Minimum diameter

De - oD : Diametro esterno - Outside diameter

# Mole a profilare CN - Dm60

Profiling wheels for CNC



NICOLAI  
DIAMANT  
diamond tools

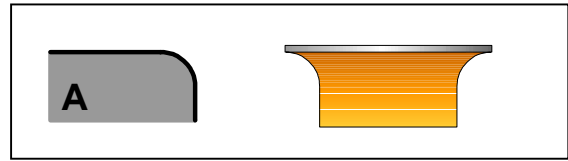

Profilo / Shape		<b>A20</b>		<b>Codice</b>	<b>Tipo</b>	<b>Grana</b>	<b>Gr.</b>	<b>Gr.</b>	<b>Mr.</b>	<b>Mr+Gr</b>	<b>Eng.</b>
Lastra / Slab		20		<b>Code</b>	<b>Type</b>	<b>Grit</b>	<b>4D+2A</b>	<b>3D+3A</b>	<b>3D+3A</b>	<b>4D+3A</b>	<b>4D+3DF</b>
Raggio / Radius		10									
Dm / mD	60	ASS10005	SEG	P1	G	G				G	E
DE / oD	85	ASF10020	FC	P3	G	G				M+G	E
Foro / Bore av.	35-30-22	ASF10025	FC	P4	G						E
		ASF10030	FC	P5	G	G				M+G	E
		ASE10040	ELE	E1					M	M	
		ASE10050	ELE	E2					M		
		ASE10060	ELE	E3					M		
Dimensioni / Dimentions:		ASR10070	ABR	220		G			M	G	
	D100x50	ASR10075	ABR	400	G	G			M	M+G	
Foro / Bore av.	35-30-22	ASR10080	ABR	1000	G	G			M	M+G	
Dm / mD	70	CSD12005	DIAFLEX	800							E
Foro / Bore av.	35-30-22	CSD12006	DIAFLEX	1500							E
		CSD12007	DIAFLEX	3000							E
							<b>0</b>	<b>0</b>	<b>0</b>	<b>0</b>	<b>0</b>

Profilo / Shape		<b>A30</b>		<b>Codice</b>	<b>Tipo</b>	<b>Grana</b>	<b>Gr.</b>	<b>Gr.</b>	<b>Mr.</b>	<b>Mr+Gr</b>	<b>Eng.</b>
Lastra / Slab		30		<b>Code</b>	<b>Type</b>	<b>Grit</b>	<b>4D+2A</b>	<b>3D+3A</b>	<b>3D+3A</b>	<b>4D+3A</b>	<b>4D+3DF</b>
Raggio / Radius		15									
Dm / mD	60	ASS10105	SEG	P1	G	G				G	E
DE / oD	95	ASF10120	FC	P3	G	G				M+G	E
Foro / Bore av.	35-30-22	ASF10125	FC	P4	G						E
		ASF10130	FC	P5	G	G				M+G	E
		ASE10140	ELE	E1					M	M	
		ASE10150	ELE	E2					M		
		ASE10160	ELE	E3					M		
Dimensioni / Dimentions:		ASR10170	ABR	220		G			M	G	
	D103x50	ASR10175	ABR	400	G	G			M	M+G	
Foro / Bore av.	35-30-22	ASR10180	ABR	1000	G	G			M	M+G	
Dm / mD	70	CSD12015	DIAFLEX	800							E
Foro / Bore av.	35-30-22	CSD12016	DIAFLEX	1500							E
		CSD12017	DIAFLEX	3000							E
							<b>0</b>	<b>0</b>	<b>0</b>	<b>0</b>	<b>0</b>

Profilo / Shape		<b>A40</b>		<b>Codice</b>	<b>Tipo</b>	<b>Grana</b>	<b>Gr.</b>	<b>Gr.</b>	<b>Mr.</b>	<b>Mr+Gr</b>	<b>Eng.</b>
Lastra / Slab		40		<b>Code</b>	<b>Type</b>	<b>Grit</b>	<b>4D+2A</b>	<b>3D+3A</b>	<b>3D+3A</b>	<b>4D+3A</b>	<b>4D+3DF</b>
Raggio / Radius		20									
Dm / mD	60	ASS10205	SEG	P1	G	G				G	E
DE / oD	105	ASF10220	FC	P3	G	G				M+G	E
Foro / Bore av.	35-30-22	ASF10225	FC	P4	G						E
		ASF10230	FC	P5	G	G				M+G	E
		ASE10240	ELE	E1					M	M	
		ASE10250	ELE	E2					M		
		ASE10260	ELE	E3					M		
Dimensioni / Dimentions:		ASR10270	ABR	220		G			M	G	
	D112x60	ASR10275	ABR	400	G	G			M	M+G	
Foro / Bore av.	35-30-22	ASR10280	ABR	1000	G	G			M	M+G	
Dm / mD	70	CSD12035	DIAFLEX	800							E
Foro / Bore av.	35-30-22	CSD12036	DIAFLEX	1500							E
		CSD12037	DIAFLEX	3000							E
							<b>0</b>	<b>0</b>	<b>0</b>	<b>0</b>	<b>0</b>

# Mole a profilare CN - Dm60

Profiling wheels for CNC



**N I C O L A I**  
D I A M A N T  
diamond tools

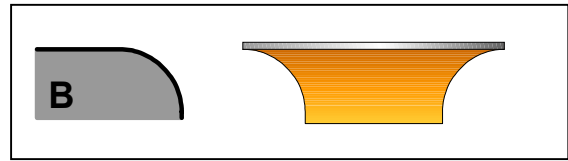

Profilo / Shape	<b>B20</b>	<b>Codice</b>	<b>Tipo</b>	<b>Grana</b>	<b>Gr.</b>	<b>Gr.</b>	<b>Mr.</b>	<b>Mr+Gr</b>	<b>Eng.</b>
Lastra / Slab	20	Code	Type	Grit	4D+2A	3D+3A	3D+3A	4D+3A	4D+3DF
Raggio / Radius	20								
Dm / mD	60	ASS10305	SEG	P1	G	G		G	E
DE / oD	105	ASF10320	FC	P3	G	G		M+G	E
Foro / Bore av.	35-30-22	ASF10325	FC	P4	G				E
		ASF10330	FC	P5	G	G		M+G	E
		ASE10340	ELE	E1			M	M	
		ASE10350	ELE	E2			M		
		ASE10360	ELE	E3			M		
<b>Dimensioni / Dimentions:</b>									
D112x50		ASR10370	ABR	220		G	M	G	
Foro / Bore av.	35-30-22	ASR10375	ABR	400	G	G	M	M+G	
		ASR10380	ABR	1000	G	G	M	M+G	
Dm / mD	70	CSD12045	DIAFLEX	800					E
Foro / Bore av.	35-30-22	CSD12046	DIAFLEX	1500					E
		CSD12047	DIAFLEX	3000					E
					<b>0</b>	<b>0</b>	<b>0</b>	<b>0</b>	<b>0</b>

Profilo / Shape	<b>B30</b>	<b>Codice</b>	<b>Tipo</b>	<b>Grana</b>	<b>Gr.</b>	<b>Gr.</b>	<b>Mr.</b>	<b>Mr+Gr</b>	<b>Eng.</b>
Lastra / Slab	30	Code	Type	Grit	4D+2A	3D+3A	3D+3A	4D+3A	4D+3DF
Raggio / Radius	30								
Dm / mD	60	ASS10405	SEG	P1	G	G		G	E
DE / oD	125	ASF10420	FC	P3	G	G		M+G	E
Foro / Bore av.	35-30-22	ASF10425	FC	P4	G				E
		ASF10430	FC	P5	G	G		M+G	E
		ASE10440	ELE	E1			M	M	
		ASE10450	ELE	E2			M		
		ASE10460	ELE	E3			M		
<b>Dimensioni / Dimentions:</b>									
D146x50		ASR10470	ABR	220		G	M	G	
Foro / Bore av.	35-30-22	ASR10475	ABR	400	G	G	M	M+G	
		ASR10480	ABR	1000	G	G	M	M+G	
Dm / mD	70	CSD12055	DIAFLEX	800					E
Foro / Bore av.	35-30-22	CSD12056	DIAFLEX	1500					E
		CSD12057	DIAFLEX	3000					E
					<b>0</b>	<b>0</b>	<b>0</b>	<b>0</b>	<b>0</b>

Profilo / Shape	<b>B40</b>	<b>Codice</b>	<b>Tipo</b>	<b>Grana</b>	<b>Gr.</b>	<b>Gr.</b>	<b>Mr.</b>	<b>Mr+Gr</b>	<b>Eng.</b>
Lastra / Slab	40	Code	Type	Grit	4D+2A	3D+3A	3D+3A	4D+3A	4D+3DF
Raggio / Radius	40								
Dm / mD	60	ASS10505	SEG	P1	G	G		G	
DE / oD	130	ASF10520	FC	P3	G	G		M+G	
Foro / Bore av.	35-30-22	ASF10525	FC	P4	G				
		ASF10530	FC	P5	G	G		M+G	
		ASE10540	ELE	E1			M	M	
		ASE10550	ELE	E2			M		
		ASE10560	ELE	E3			M		
<b>Dimensioni / Dimentions:</b>									
D135x60		ASR10570	ABR	220		G	M	G	
Foro / Bore av.	35-30-22	ASR10575	ABR	400	G	G	M	M+G	
		ASR10580	ABR	1000	G	G	M	M+G	
Dm / mD	70		DIAFLEX	800					
Foro / Bore av.	35-30-22		DIAFLEX	1500					
			DIAFLEX	3000					
					<b>0</b>	<b>0</b>	<b>0</b>	<b>0</b>	



## Mole a profilare CN - Dm60

Profiling wheels for CNC

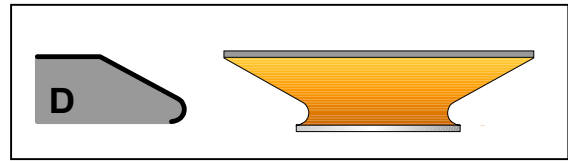

Profilo / Shape		<b>D20</b>		Codice	Tipo	Grana	Gr.	Gr.	Mr.	Mr+Gr	Eng.
Lastra / Slab		20									
Raggio / Radius				Code	Type	Grit	4D+2A	3D+3A	3D+3A	4D+3A	4D+3DF
Dm / mD	60	ASS10605	SEG	P1	G	G				G	
DE / oD	109	ASF10620	FC	P3	G	G				M+G	
Foro / Bore av.	35-30-22	ASF10625	FC	P4	G						
		ASF10630	FC	P5	G	G				M+G	
		ASE10640	ELE	E1					M	M	
		ASE10650	ELE	E2					M		
		ASE10660	ELE	E3					M		
Dimensioni / Dimentions:		ASR10670	ABR	220		G			M	G	
D126x50		ASR10675	ABR	400	G	G			M	M+G	
Foro / Bore av.	35-30-22	ASR10680	ABR	1000	G	G			M	M+G	
Dm / mD	70 mm		DIAFLEX	800							
Foro / Bore av.	35-30-22		DIAFLEX	1500							
			DIAFLEX	3000							
							<b>0</b>	<b>0</b>	<b>0</b>	<b>0</b>	

Profilo / Shape		<b>D30</b>		Codice	Tipo	Grana	Gr.	Gr.	Mr.	Mr+Gr	Eng.
Lastra / Slab		30									
Raggio / Radius				Code	Type	Grit	4D+2A	3D+3A	3D+3A	4D+3A	4D+3DF
Dm / mD	60	ASS10705	SEG	P1	G	G				G	E
DE / oD	130	ASF10720	FC	P3	G	G				M+G	E
Foro / Bore av.	35-30-22	ASF10725	FC	P4	G						E
		ASF10730	FC	P5	G	G				M+G	E
		ASE10740	ELE	E1					M	M	
		ASE10750	ELE	E2					M		
		ASE10760	ELE	E3					M		
Dimensioni / Dimentions:		ASR10770	ABR	220		G			M	G	
D148x49		ASR10775	ABR	400	G	G			M	M+G	
Foro / Bore av.	35-30-22	ASR10780	ABR	1000	G	G			M	M+G	
Dm / mD	70	CSD12085	DIAFLEX	800							E
Foro / Bore av.	35-30-22	CSD12086	DIAFLEX	1500							E
		CSD12087	DIAFLEX	3000							E
							<b>0</b>	<b>0</b>	<b>0</b>	<b>0</b>	<b>0</b>

Profilo / Shape		<b>D40</b>		Codice	Tipo	Grana	Gr.	Gr.	Mr.	Mr+Gr	Eng.
Lastra / Slab		40									
Raggio / Radius				Code	Type	Grit	4D+2A	3D+3A	3D+3A	4D+3A	4D+3DF
Dm / mD	60	ASS10805	SEG	P1	G	G				G	
DE / oD		ASF10820	FC	P3	G	G				M+G	
Foro / Bore av.	35-30-22	ASF10825	FC	P4	G						
		ASF10830	FC	P5	G	G				M+G	
		ASE10840	ELE	E1					M	M	
		ASE10850	ELE	E2					M		
		ASE10860	ELE	E3					M		
Dimensioni / Dimentions:		ASR10870	ABR	220		G			M	G	
ASR10875		ABR	400		G	G			M	M+G	
Foro / Bore av.	35-30-22	ASR10880	ABR	1000	G	G			M	M+G	
Dm / mD	70		DIAFLEX	800							
Foro / Bore av.	35-30-22		DIAFLEX	1500							
			DIAFLEX	3000							
							<b>0</b>	<b>0</b>	<b>0</b>	<b>0</b>	

# Mole a profilare CN - Dm60

Profiling wheels for CNC



N I C O L A I  
D I A M A N T  
diamond tools

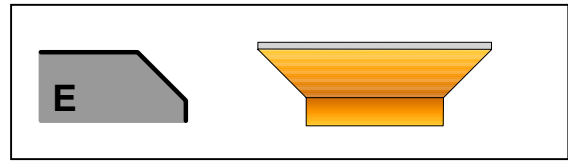

Profilo / Shape		<b>E20</b>		Codice Code	Tipo Type	Grana Grit	Gr. 4D+2A	Gr. 3D+3A	Mr. 3D+3A	Mr+Gr 4D+3A	Eng. 4D+3DF	
Lastra / Slab	20											
Raggio / Radius												
Dm / mD	60	ASS10905	SEG	P1	G	G				G	E	
DE / oD	92	ASF10920	FC	P3	G	G				M+G	E	
Foro / Bore av.	35-30-22	ASF10925	FC	P4	G						E	
		ASF10930	FC	P5	G	G				M+G	E	
		ASE10940	ELE	E1					M	M		
		ASE10950	ELE	E2					M			
		ASE10960	ELE	E3					M			
Dimensioni / Dimentions:		ASR10970	ABR	220				G	M	G		
D128x50		ASR10975	ABR	400	G	G			M	M+G		
Foro / Bore av.	35-30-22	ASR10980	ABR	1000	G	G			M	M+G		
Dm / mD	70	CSD12105	DIAFLEX	800							E	
Foro / Bore av.	35-30-22	CSD12106	DIAFLEX	1500							E	
		CSD12107	DIAFLEX	3000							E	
							<b>0</b>	<b>0</b>	<b>0</b>	<b>0</b>	<b>0</b>	

Profilo / Shape		<b>E30</b>		Codice Code	Tipo Type	Grana Grit	Gr. 4D+2A	Gr. 3D+3A	Mr. 3D+3A	Mr+Gr 4D+3A	Eng. 4D+3DF	
Lastra / Slab	30											
Raggio / Radius												
Dm / mD	60	ASS11005	SEG	P1	G	G				G	E	
DE / oD	104	ASF11020	FC	P3	G	G				M+G	E	
Foro / Bore av.	35-30-22	ASF11025	FC	P4	G						E	
		ASF11030	FC	P5	G	G				M+G	E	
		ASE11040	ELE	E1					M	M		
		ASE11050	ELE	E2					M			
		ASE11060	ELE	E3					M			
Dimensioni / Dimentions:		ASR11070	ABR	220				G	M	G		
D128x50		ASR11075	ABR	400	G	G			M	M+G		
Foro / Bore av.	35-30-22	ASR11080	ABR	1000	G	G			M	M+G		
Dm / mD	70	CSD12115	DIAFLEX	800							E	
Foro / Bore av.	35-30-22	CSD12116	DIAFLEX	1500							E	
		CSD12117	DIAFLEX	3000							E	
							<b>0</b>	<b>0</b>	<b>0</b>	<b>0</b>	<b>0</b>	

Profilo / Shape		<b>E40</b>		Codice Code	Tipo Type	Grana Grit	Gr. 4D+2A	Gr. 3D+3A	Mr. 3D+3A	Mr+Gr 4D+3A	Eng. 4D+3DF	
Lastra / Slab	40											
Raggio / Radius												
Dm / mD	60	ASS11105	SEG	P1	G	G				G		
DE / oD		ASF11120	FC	P3	G	G				M+G		
Foro / Bore av.	35-30-22	ASF11125	FC	P4	G							
		ASF11130	FC	P5	G	G				M+G		
		ASE11140	ELE	E1					M	M		
		ASE11150	ELE	E2					M			
		ASE11160	ELE	E3					M			
Dimensioni / Dimentions:		ASR11170	ABR	220				G	M	G		
D128x50		ASR11175	ABR	400	G	G			M	M+G		
Foro / Bore av.	35-30-22	ASR11180	ABR	1000	G	G			M	M+G		
Dm / mD	70		DIAFLEX	800								
Foro / Bore av.	35-30-22		DIAFLEX	1500								
			DIAFLEX	3000								
							<b>0</b>	<b>0</b>	<b>0</b>	<b>0</b>		

# Mole a profilare CN - Dm60

Profiling wheels for CNC



NICOLAI  
DIAMANT  
diamond tools

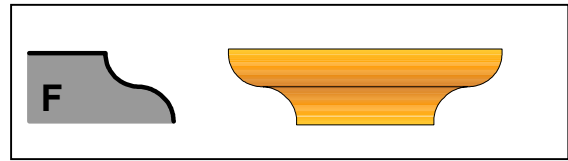

Profilo / Shape	F20	Codice	Tipo	Grana	Gr.	Gr.	Mr.	Mr+Gr	Eng.
Lastra / Slab	20	Code	Type	Grit	4D+2A	3D+3A	3D+3A	4D+3A	4D+3DF
Raggio / Radius	10+10								
Dm / mD	60	ASS11205	SEG	P1	G	G		G	E
DE / oD	100	ASF11220	FC	P3	G	G		M+G	E
Foro / Bore av.	35-30-22	ASF11225	FC	P4	G				E
		ASF11230	FC	P5	G	G		M+G	E
		ASE11240	ELE	E1			M	M	
		ASE11250	ELE	E2			M		
		ASE11260	ELE	E3			M		
Dimensioni / Dimentions:		ASR11270	ABR	220		G	M	G	
	D112x50	ASR11275	ABR	400	G	G	M	M+G	
Foro / Bore av.	35-30-22	ASR11280	ABR	1000	G	G	M	M+G	
Dm / mD	70 mm	CSD12135	DIAFLEX	800					E
Foro / Bore av.	35-30-22	CSD12136	DIAFLEX	1500					E
		CSD12137	DIAFLEX	3000					E
					0	0	0	0	0

Profilo / Shape	F30	Codice	Tipo	Grana	Gr.	Gr.	Mr.	Mr+Gr	Eng.
Lastra / Slab	30	Code	Type	Grit	4D+2A	3D+3A	3D+3A	4D+3A	4D+3DF
Raggio / Radius	15+15								
Dm / mD	60	ASS11305	SEG	P1	G	G		G	E
DE / oD	120	ASF11320	FC	P3	G	G		M+G	E
Foro / Bore av.	35-30-22	ASF11325	FC	P4	G				E
		ASF11330	FC	P5	G	G		M+G	E
		ASE11340	ELE	E1			M	M	
		ASE11350	ELE	E2			M		
		ASE11360	ELE	E3			M		
Dimensioni / Dimentions:		ASR11370	ABR	220		G	M	G	
	D132x50	ASR11375	ABR	400	G	G	M	M+G	
Foro / Bore av.	35-30-22	ASR11380	ABR	1000	G	G	M	M+G	
Dm / mD	70	CSD12145	DIAFLEX	800					E
Foro / Bore av.	35-30-22	CSD12146	DIAFLEX	1500					E
		CSD12147	DIAFLEX	3000					E
					0	0	0	0	0

Profilo / Shape	F40	Codice	Tipo	Grana	Gr.	Gr.	Mr.	Mr+Gr	Eng.
Lastra / Slab	40	Code	Type	Grit	4D+2A	3D+3A	3D+3A	4D+3A	4D+3DF
Raggio / Radius	20+20								
Dm / mD	60	ASS11405	SEG	P1	G	G		G	E
DE / oD	128	ASF11420	FC	P3	G	G		M+G	E
Foro / Bore av.	35-30-22	ASF11425	FC	P4	G				E
		ASF11430	FC	P5	G	G		M+G	E
		ASE11440	ELE	E1			M	M	
		ASE11450	ELE	E2			M		
		ASE11460	ELE	E3			M		
Dimensioni / Dimentions:		ASR11470	ABR	220		G	M	G	
	D138x60	ASR11475	ABR	400	G	G	M	M+G	
Foro / Bore av.	35-30-22	ASR11480	ABR	1000	G	G	M	M+G	
Dm / mD	70	CSD12155	DIAFLEX	800					E
Foro / Bore av.	35-30-22	CSD12156	DIAFLEX	1500					E
		CSD12157	DIAFLEX	3000					E
					0	0	0	0	0

# Mole a profilare CN - Dm60

Profiling wheels for CNC



**N I C O L A I**  
**D I A M A N T**  
diamond tools

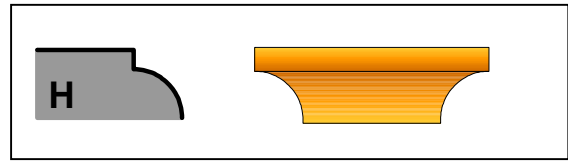

Profilo / Shape	H20	Codice	Tipo	Grana	Gr.	Gr.	Mr.	Mr+Gr	Eng.
Lastra / Slab	20	Code	Type	Grit	4D+2A	3D+3A	3D+3A	4D+3A	4D+3DF
Raggio / Radius	15								
Dm / mD	60	ASS11505	SEG	P1	G	G		G	E
DE / oD	90	ASF11520	FC	P3	G	G		M+G	E
Foro / Bore av.	35-30-22	ASF11525	FC	P4	G				E
		ASF11530	FC	P5	G	G		M+G	E
		ASE11540	ELE	E1			M	M	
		ASE11550	ELE	E2			M		
		ASE11560	ELE	E3			M		
Dimensioni / Dimentions:		ASR11570	ABR	220		G	M	G	
	D98x50	ASR11575	ABR	400	G	G	M	M+G	
Foro / Bore av.	35-30-22	ASR11580	ABR	1000	G	G	M	M+G	
Dm / mD	70	CSD12195	DIAFLEX	800					E
Foro / Bore av.	35-30-22	CSD12196	DIAFLEX	1500					E
		CSD12197	DIAFLEX	3000					E
					0	0	0	0	0

Profilo / Shape	H30	Codice	Tipo	Grana	Gr.	Gr.	Mr.	Mr+Gr	Eng.
Lastra / Slab	30	Code	Type	Grit	4D+2A	3D+3A	3D+3A	4D+3A	4D+3DF
Raggio / Radius	20								
Dm / mD	60	ASS11605	SEG	P1	G	G		G	E
DE / oD	110	ASF11620	FC	P3	G	G		M+G	E
Foro / Bore av.	35-30-22	ASF11625	FC	P4	G				E
		ASF11630	FC	P5	G	G		M+G	E
		ASE11640	ELE	E1			M	M	
		ASE11650	ELE	E2			M		
		ASE11660	ELE	E3			M		
Dimensioni / Dimentions:		ASR11670	ABR	220		G	M	G	
	D127x50	ASR11675	ABR	400	G	G	M	M+G	
Foro / Bore av.	35-30-22	ASR11680	ABR	1000	G	G	M	M+G	
Dm / mD	70	CSD12205	DIAFLEX	800					E
Foro / Bore av.	35-30-22	CSD12206	DIAFLEX	1500					E
		CSD12207	DIAFLEX	3000					E
					0	0	0	0	0

Profilo / Shape	H40	Codice	Tipo	Grana	Gr.	Gr.	Mr.	Mr+Gr	Eng.
Lastra / Slab	40	Code	Type	Grit	4D+2A	3D+3A	3D+3A	4D+3A	4D+3DF
Raggio / Radius	30								
Dm / mD	60	ASS11705	SEG	P1	G	G		G	
DE / oD	120	ASF11720	FC	P3	G	G		M+G	
Foro / Bore av.	35-30-22	ASF11725	FC	P4	G				
		ASF11730	FC	P5	G	G		M+G	
		ASE11740	ELE	E1			M	M	
		ASE11750	ELE	E2			M		
		ASE11760	ELE	E3			M		
Dimensioni / Dimentions:		ASR11770	ABR	220		G	M	G	
	D130x60	ASR11775	ABR	400	G	G	M	M+G	
Foro / Bore av.	35-30-22	ASR11780	ABR	1000	G	G	M	M+G	
Dm / mD	70		DIAFLEX	800					
Foro / Bore av.	35-30-22		DIAFLEX	1500					
			DIAFLEX	3000					
					0	0	0	0	

# Mole a profilare CN - Dm60

Profiling wheels for CNC



**N I C O L A I**  
**D I A M A N T**  
diamond tools

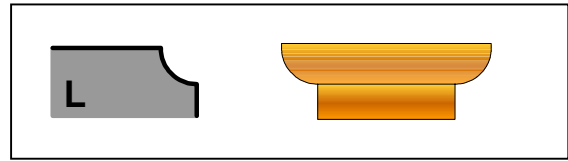

Profilo / Shape		<b>L20</b>		<b>Codice</b>	<b>Tipo</b>	<b>Grana</b>	<b>Gr.</b>	<b>Gr.</b>	<b>Mr.</b>	<b>Mr+Gr</b>	<b>Eng.</b>
Lastra / Slab		20		<b>Code</b>	<b>Type</b>	<b>Grit</b>	<b>4D+2A</b>	<b>3D+3A</b>	<b>3D+3A</b>	<b>4D+3A</b>	<b>4D+3DF</b>
Raggio / Radius		10									
Dm / mD	60	ASS11805	SEG	P1	G	G				G	E
DE / oD	80	ASF11820	FC	P3	G	G				M+G	E
Foro / Bore av.	35-30-22	ASF11825	FC	P4	G						E
		ASF11830	FC	P5	G	G				M+G	E
		ASE11840	ELE	E1					M	M	
		ASE11850	ELE	E2					M		
		ASE11860	ELE	E3					M		
Dimensioni / Dimentions:		ASR11870	ABR	220				G	M	G	
	D100x50	ASR11875	ABR	400	G	G			M	M+G	
Foro / Bore av.	35-30-22	ASR11880	ABR	1000	G	G			M	M+G	
Dm / mD	70	CSD12255	DIAFLEX	800							E
Foro / Bore av.	35-30-22	CSD12256	DIAFLEX	1500							E
		CSD12257	DIAFLEX	3000							E
							<b>0</b>	<b>0</b>	<b>0</b>	<b>0</b>	<b>0</b>

Profilo / Shape		<b>L30</b>		<b>Codice</b>	<b>Tipo</b>	<b>Grana</b>	<b>Gr.</b>	<b>Gr.</b>	<b>Mr.</b>	<b>Mr+Gr</b>	<b>Eng.</b>
Lastra / Slab		30		<b>Code</b>	<b>Type</b>	<b>Grit</b>	<b>4D+2A</b>	<b>3D+3A</b>	<b>3D+3A</b>	<b>4D+3A</b>	<b>4D+3DF</b>
Raggio / Radius		15									
Dm / mD	60	ASS11905	SEG	P1	G	G				G	E
DE / oD	90	ASF11920	FC	P3	G	G				M+G	E
Foro / Bore av.	35-30-22	ASF11925	FC	P4	G						E
		ASF11930	FC	P5	G	G				M+G	E
		ASE11940	ELE	E1					M	M	
		ASE11950	ELE	E2					M		
		ASE11960	ELE	E3					M		
Dimensioni / Dimentions:		ASR11970	ABR	220				G	M	G	
	D118x50	ASR11975	ABR	400	G	G			M	M+G	
Foro / Bore av.	35-30-22	ASR11980	ABR	1000	G	G			M	M+G	
Dm / mD	70		DIAFLEX	800							E
Foro / Bore av.	35-30-22		DIAFLEX	1500							E
			DIAFLEX	3000							E
							<b>0</b>	<b>0</b>	<b>0</b>	<b>0</b>	<b>0</b>

Profilo / Shape		<b>L40</b>		<b>Codice</b>	<b>Tipo</b>	<b>Grana</b>	<b>Gr.</b>	<b>Gr.</b>	<b>Mr.</b>	<b>Mr+Gr</b>	<b>Eng.</b>
Lastra / Slab		40		<b>Code</b>	<b>Type</b>	<b>Grit</b>	<b>4D+2A</b>	<b>3D+3A</b>	<b>3D+3A</b>	<b>4D+3A</b>	<b>4D+3DF</b>
Raggio / Radius		20									
Dm / mD	60	ASS12005	SEG	P1	G	G				G	E
DE / oD	100	ASF12020	FC	P3	G	G				M+G	E
Foro / Bore av.	35-30-22	ASF12025	FC	P4	G						E
		ASF12030	FC	P5	G	G				M+G	E
		ASE12040	ELE	E1					M	M	
		ASE12050	ELE	E2					M		
		ASE12060	ELE	E3					M		
Dimensioni / Dimentions:		ASR12070	ABR	220				G	M	G	
		ASR12075	ABR	400	G	G			M	M+G	
Foro / Bore av.	35-30-22	ASR12080	ABR	1000	G	G			M	M+G	
Dm / mD	70		DIAFLEX	800							E
Foro / Bore av.	35-30-22		DIAFLEX	1500							E
			DIAFLEX	3000							E
							<b>0</b>	<b>0</b>	<b>0</b>	<b>0</b>	<b>0</b>

# Mole a profilare CN - Dm60

Profiling wheels for CNC



**N I C O L A I**  
**D I A M A N T**  
diamond tools

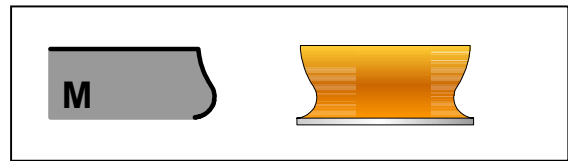

Profilo / Shape		<b>M20</b>		Codice	Tipo	Grana	Gr.	Gr.	Mr.	Mr+Gr	Eng.
Lastra / Slab		20									
Dm / mD	60	ASS12105	SEG	P1	G	G				G	E
DE / oD		ASF12120	FC	P3	G	G				M+G	E
Foro / Bore av.	35-30-22	ASF12125	FC	P4	G						E
		ASF12130	FC	P5	G	G				M+G	E
		ASE12140	ELE	E1					M	M	
		ASE12150	ELE	E2					M		
		ASE12160	ELE	E3					M		
Dimensioni / Dimentions:		ASR12170	ABR	220		G			M	G	
		ASR12175	ABR	400	G	G			M	M+G	
Foro / Bore av.	35-30-22	ASR12180	ABR	1000	G	G			M	M+G	
Dm / mD	70		DIAFLEX	800							E
Foro / Bore av.	35-30-22		DIAFLEX	1500							E
			DIAFLEX	3000							E
							<b>0</b>	<b>0</b>	<b>0</b>	<b>0</b>	<b>0</b>

Profilo / Shape		<b>M30</b>		Codice	Tipo	Grana	Gr.	Gr.	Mr.	Mr+Gr	Eng.
Lastra / Slab		30									
Dm / mD	60	ASS12205	SEG	P1	G	G				G	E
DE / oD	82	ASF12220	FC	P3	G	G				M+G	E
Foro / Bore av.	35-30-22	ASF12225	FC	P4	G						E
		ASF12230	FC	P5	G	G				M+G	E
		ASE12240	ELE	E1					M	M	
		ASE12250	ELE	E2					M		
		ASE12260	ELE	E3					M		
Dimensioni / Dimentions:		ASR12270	ABR	220		G			M	G	
	D98x50	ASR12275	ABR	400	G	G			M	M+G	
Foro / Bore av.	35-30-22	ASR12280	ABR	1000	G	G			M	M+G	
Dm / mD	70		DIAFLEX	800							E
Foro / Bore av.	35-30-22		DIAFLEX	1500							E
			DIAFLEX	3000							E
							<b>0</b>	<b>0</b>	<b>0</b>	<b>0</b>	<b>0</b>

Profilo / Shape		<b>M40</b>		Codice	Tipo	Grana	Gr.	Gr.	Mr.	Mr+Gr	Eng.
Lastra / Slab		40									
Dm / mD	60	ASS12305	SEG	P1	G	G				G	E
DE / oD		ASF12320	FC	P3	G	G				M+G	E
Foro / Bore av.	35-30-22	ASF12325	FC	P4	G						E
		ASF12330	FC	P5	G	G				M+G	E
		ASE12340	ELE	E1					M	M	
		ASE12350	ELE	E2					M		
		ASE12360	ELE	E3					M		
Dimensioni / Dimentions:		ASR12370	ABR	220		G			M	G	
		ASR12375	ABR	400	G	G			M	M+G	
Foro / Bore av.	30-35-22	ASR12380	ABR	1000	G	G			M	M+G	
Dm / mD	70		DIAFLEX	800							E
Foro / Bore av.	30-35-22		DIAFLEX	1500							E
			DIAFLEX	3000							E
							<b>0</b>	<b>0</b>	<b>0</b>	<b>0</b>	<b>0</b>

# Mole a profilare CN - Dm60

Profiling wheels for CNC



**N I C O L A I**  
**D I A M A N T**  
diamond tools

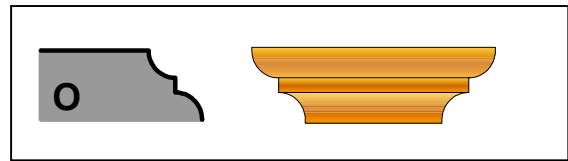

Profilo / Shape		<b>O20</b>		Codice Code	Tipo Type	Grana Grit	Gr. 4D+2A	Gr. 3D+3A	Mr. 3D+3A	Mr+Gr 4D+3A	Eng. 4D+3DF
Lastra / Slab		20									
Dm / mD	60	ASS12405	SEG	P1	G	G				G	E
DE / oD	92	ASF12420	FC	P3	G	G				M+G	E
Foro / Bore av.	35-30-22	ASF12425	FC	P4	G						E
		ASF12430	FC	P5	G	G				M+G	E
		ASE12440	ELE	E1					M	M	
		ASE12450	ELE	E2					M		
		ASE12460	ELE	E3					M		
Dimensioni / Dimentions:		ASR12470	ABR	220				G	M	G	
D100x50		ASR12475	ABR	400	G	G			M	M+G	
Foro / Bore av.	35-30-22	ASR12480	ABR	1000	G	G			M	M+G	
Dm / mD	70	CSD12285	DIAFLEX	800							E
Foro / Bore av.	35-30-22	CSD12286	DIAFLEX	1500							E
		CSD12287	DIAFLEX	3000							E
							<b>0</b>	<b>0</b>	<b>0</b>	<b>0</b>	<b>0</b>

Profilo / Shape		<b>O30</b>		Codice Code	Tipo Type	Grana Grit	Gr. 4D+2A	Gr. 3D+3A	Mr. 3D+3A	Mr+Gr 4D+3A	Eng. 4D+3DF
Lastra / Slab		30									
Dm / mD	60	ASS12505	SEG	P1	G	G				G	E
DE / oD	110	ASF12520	FC	P3	G	G				M+G	E
Foro / Bore av.	35-30-22	ASF12525	FC	P4	G						E
		ASF12530	FC	P5	G	G				M+G	E
		ASE12540	ELE	E1					M	M	
		ASE12550	ELE	E2					M		
		ASE12560	ELE	E3					M		
Dimensioni / Dimentions:		ASR12570	ABR	220				G	M	G	
D124x50		ASR12575	ABR	400	G	G			M	M+G	
Foro / Bore av.	35-30-22	ASR12580	ABR	1000	G	G			M	M+G	
Dm / mD	70	CSD12295	DIAFLEX	800							E
Foro / Bore av.	35-30-22	CSD12296	DIAFLEX	1500							E
		CSD12297	DIAFLEX	3000							E
							<b>0</b>	<b>0</b>	<b>0</b>	<b>0</b>	<b>0</b>

Profilo / Shape		<b>O40</b>		Codice Code	Tipo Type	Grana Grit	Gr. 4D+2A	Gr. 3D+3A	Mr. 3D+3A	Mr+Gr 4D+3A	Eng. 4D+3DF
Lastra / Slab		40									
Dm / mD	60	ASS12605	SEG	P1	G	G				G	
DE / oD	128	ASF12620	FC	P3	G	G				M+G	
Foro / Bore av.	35-30-22	ASF12625	FC	P4	G						
		ASF12630	FC	P5	G	G				M+G	
		ASE12640	ELE	E1					M	M	
		ASE12650	ELE	E2					M		
		ASE12660	ELE	E3					M		
Dimensioni / Dimentions:		ASR12670	ABR	220				G	M	G	
D135x60		ASR12675	ABR	400	G	G			M	M+G	
Foro / Bore av.	35-30-22	ASR12680	ABR	1000	G	G			M	M+G	
Dm / mD	70		DIAFLEX	800							
Foro / Bore av.	35-30-22		DIAFLEX	1500							
			DIAFLEX	3000							
							<b>0</b>	<b>0</b>	<b>0</b>	<b>0</b>	

# Mole a profilare CN - Dm60

Profiling wheels for CNC



**N I C O L A I**  
**D I A M A N T**  
diamond tools

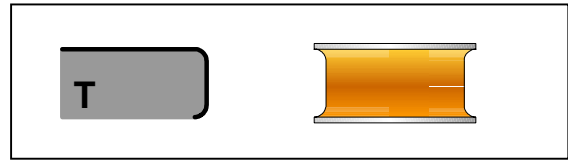

Profilo / Shape		<b>T20</b>	<b>Codice</b>	<b>Tipo</b>	<b>Grana</b>	<b>Gr.</b>	<b>Gr.</b>	<b>Mr.</b>	<b>Mr+Gr</b>	<b>Eng.</b>
Lastra / Slab		20	<i>Code</i>	<i>Type</i>	<i>Grit</i>	<b>4D+2A</b>	<b>3D+3A</b>	<b>3D+3A</b>	<b>4D+3A</b>	<b>4D+3DF</b>
Raggio / Radius		3								
Dm / mD	60	ASS12705	SEG	P1	G	G			G	E
DE / oD	75	ASF12720	FC	P3	G	G			M+G	E
Foro / Bore av.	35-30-22	ASF12725	FC	P4	G					E
		ASF12730	FC	P5	G	G			M+G	E
		ASE12740	ELE	E1				M	M	
		ASE12750	ELE	E2				M		
		ASE12760	ELE	E3				M		
Dimensioni / Dimentions:		ASR12770	ABR	220			G	M	G	
D100x50		ASR12775	ABR	400	G	G		M	M+G	
Foro / Bore av.	35-30-22	ASR12780	ABR	1000	G	G		M	M+G	
Dm / mD	70	CSD12345	DIAFLEX	800						E
Foro / Bore av.	35-30-22	CSD12346	DIAFLEX	1500						E
		CSD12347	DIAFLEX	3000						E
						<b>0</b>	<b>0</b>	<b>0</b>	<b>0</b>	<b>0</b>

Profilo / Shape		<b>T30</b>	<b>Codice</b>	<b>Tipo</b>	<b>Grana</b>	<b>Gr.</b>	<b>Gr.</b>	<b>Mr.</b>	<b>Mr+Gr</b>	<b>Eng.</b>
Lastra / Slab		30	<i>Code</i>	<i>Type</i>	<i>Grit</i>	<b>4D+2A</b>	<b>3D+3A</b>	<b>3D+3A</b>	<b>4D+3A</b>	<b>4D+3DF</b>
Raggio / Radius		5								
Dm / mD	60	ASS12805	SEG	P1	G	G			G	E
DE / oD	75	ASF12820	FC	P3	G	G			M+G	E
Foro / Bore av.	35-30-22	ASF12825	FC	P4	G					E
		ASF12830	FC	P5	G	G			M+G	E
		ASE12840	ELE	E1				M	M	
		ASE12850	ELE	E2				M		
		ASE12860	ELE	E3				M		
Dimensioni / Dimentions:		ASR12870	ABR	220			G	M	G	
D100x50		ASR12875	ABR	400	G	G		M	M+G	
Foro / Bore av.	35-30-22	ASR12880	ABR	1000	G	G		M	M+G	
Dm / mD	70	CSD12355	DIAFLEX	800						E
Foro / Bore av.	35-30-22	CSD12356	DIAFLEX	1500						E
		CSD12357	DIAFLEX	3000						E
						<b>0</b>	<b>0</b>	<b>0</b>	<b>0</b>	<b>0</b>

Profilo / Shape		<b>T40</b>	<b>Codice</b>	<b>Tipo</b>	<b>Grana</b>	<b>Gr.</b>	<b>Gr.</b>	<b>Mr.</b>	<b>Mr+Gr</b>	<b>Eng.</b>
Lastra / Slab		40	<i>Code</i>	<i>Type</i>	<i>Grit</i>	<b>4D+2A</b>	<b>3D+3A</b>	<b>3D+3A</b>	<b>4D+3A</b>	<b>4D+3DF</b>
Raggio / Radius		5								
Dm / mD	60	ASS12905	SEG	P1	G	G			G	E
DE / oD	75	ASF12920	FC	P3	G	G			M+G	E
Foro / Bore av.	35-30-22	ASF12925	FC	P4	G					E
		ASF12930	FC	P5	G	G			M+G	E
		ASE12940	ELE	E1				M	M	
		ASE12950	ELE	E2				M		
		ASE12960	ELE	E3				M		
Dimensioni / Dimentions:		ASR12970	ABR	220			G	M	G	
D87x60		ASR12975	ABR	400	G	G		M	M+G	
Foro / Bore av.	35-30-22	ASR12980	ABR	1000	G	G		M	M+G	
Dm / mD	70	CSD12365	DIAFLEX	800						E
Foro / Bore av.	35-30-22	CSD12366	DIAFLEX	1500						E
		CSD12367	DIAFLEX	3000						E
						<b>0</b>	<b>0</b>	<b>0</b>	<b>0</b>	<b>0</b>

# Mole a profilare CN - Dm60

Profiling wheels for CNC



**N I C O L A I**  
**D I A M A N T**  
diamond tools

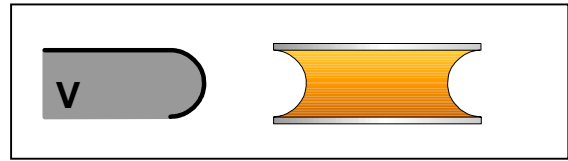

Profilo / Shape		<b>V20</b>							
Lastra / Slab	20	<b>Codice</b>	<b>Tipo</b>	<b>Grana</b>	<b>Gr.</b>	<b>Gr.</b>	<b>Mr.</b>	<b>Mr+Gr</b>	<b>Eng.</b>
Raggio / Radius	10	<i>Code</i>	<i>Type</i>	<i>Grit</i>	<b>4D+2A</b>	<b>3D+3A</b>	<b>3D+3A</b>	<b>4D+3A</b>	<b>4D+3DF</b>
Dm / mD	60	ASS13005	SEG	P1	G	G		G	E
DE / oD	85	ASF13020	FC	P3	G	G		M+G	E
Foro / Bore av.	35-30-22	ASF13025	FC	P4	G				E
		ASF13030	FC	P5	G	G		M+G	E
		ASE13040	ELE	E1				M	M
		ASE13050	ELE	E2				M	
		ASE13060	ELE	E3				M	
Dimensioni / Dimentions:		ASR13070	ABR	220		G	M	G	
	D102x50	ASR13075	ABR	400	G	G	M	M+G	
Foro / Bore av.	35-30-22	ASR13080	ABR	1000	G	G	M	M+G	
Dm / mD	70	CSD12375	DIAFLEX	800					E
Foro / Bore av.	35-30-22	CSD12376	DIAFLEX	1500					E
		CSD12377	DIAFLEX	3000					E
					<b>0</b>	<b>0</b>	<b>0</b>	<b>0</b>	<b>0</b>

Profilo / Shape		<b>V30</b>							
Lastra / Slab	30	<b>Codice</b>	<b>Tipo</b>	<b>Grana</b>	<b>Gr.</b>	<b>Gr.</b>	<b>Mr.</b>	<b>Mr+Gr</b>	<b>Eng.</b>
Raggio / Radius	15	<i>Code</i>	<i>Type</i>	<i>Grit</i>	<b>4D+2A</b>	<b>3D+3A</b>	<b>3D+3A</b>	<b>4D+3A</b>	<b>4D+3DF</b>
Dm / mD	60	ASS13105	SEG	P1	G	G		G	E
DE / oD	95	ASF13120	FC	P3	G	G		M+G	E
Foro / Bore av.	35-30-22	ASF13125	FC	P4	G				E
		ASF13130	FC	P5	G	G		M+G	E
		ASE13140	ELE	E1				M	M
		ASE13150	ELE	E2				M	
		ASE13160	ELE	E3				M	
Dimensioni / Dimentions:		ASR13170	ABR	220		G	M	G	
	D102x50	ASR13175	ABR	400	G	G	M	M+G	
Foro / Bore av.	35-30-22	ASR13180	ABR	1000	G	G	M	M+G	
Dm / mD	70	CSD12385	DIAFLEX	800					E
Foro / Bore av.	35-30-22	CSD12386	DIAFLEX	1500					E
		CSD12387	DIAFLEX	3000					E
					<b>0</b>	<b>0</b>	<b>0</b>	<b>0</b>	<b>0</b>

Profilo / Shape		<b>V40</b>							
Lastra / Slab	40	<b>Codice</b>	<b>Tipo</b>	<b>Grana</b>	<b>Gr.</b>	<b>Gr.</b>	<b>Mr.</b>	<b>Mr+Gr</b>	<b>Eng.</b>
Raggio / Radius	20	<i>Code</i>	<i>Type</i>	<i>Grit</i>	<b>4D+2A</b>	<b>3D+3A</b>	<b>3D+3A</b>	<b>4D+3A</b>	<b>4D+3DF</b>
Dm / mD	60	ASS13205	SEG	P1	G	G		G	E
DE / oD	105	ASF13220	FC	P3	G	G		M+G	E
Foro / Bore av.	35-30-22	ASF13225	FC	P4	G				E
		ASF13230	FC	P5	G	G		M+G	E
		ASE13240	ELE	E1				M	M
		ASE13250	ELE	E2				M	
		ASE13260	ELE	E3				M	
Dimensioni / Dimentions:		ASR13270	ABR	220		G	M	G	
	D112x60	ASR13275	ABR	400	G	G	M	M+G	
Foro / Bore av.	35-30-22	ASR13280	ABR	1000	G	G	M	M+G	
Dm / mD	70	CSD12395	DIAFLEX	800					E
Foro / Bore av.	35-30-22	CSD12396	DIAFLEX	1500					E
		CSD12397	DIAFLEX	3000					E
					<b>0</b>	<b>0</b>	<b>0</b>	<b>0</b>	<b>0</b>

# Mole a profilare CN - Dm60

Profiling wheels for CNC



**N I C O L A I**  
**D I A M A N T**  
diamond tools

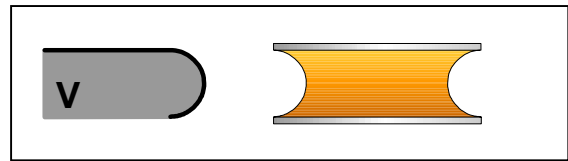

Profilo / Shape	V50	Codice	Tipo	Grana	Gr.	Gr.	Mr.	Mr+Gr	Eng.
Lastra / Slab	50	Code	Type	Grit	4D+2A	3D+3A	3D+3A	4D+3A	4D+3DF
Raggio / Radius	25								
Dm / mD	60	ASS13305	SEG	P1	G	G		G	
DE / oD	115	ASF13320	FC	P3	G	G		M+G	
Foro / Bore av.	35-30-22	ASF13325	FC	P4	G				
		ASF13330	FC	P5	G	G		M+G	
		ASE13340	ELE	E1			M	M	
		ASE13350	ELE	E2			M		
		ASE13360	ELE	E3			M		
Dimensioni / Dimentions:		ASR13374	ABR	220		G	M	G	
		ASR13375	ABR	400	G	G	M	M+G	
Foro / Bore av.	35-30-22	ASR13380	ABR	1000	G	G	M	M+G	
Dm / mD	70		DIAFLEX	800					
Foro / Bore av.	35-30-22		DIAFLEX	1500					
			DIAFLEX	3000					
					0	0	0	0	

# Mole a profilare CN - Dm60

Profiling wheels for CNC



**N I C O L A I**  
**D I A M A N T**  
diamond tools

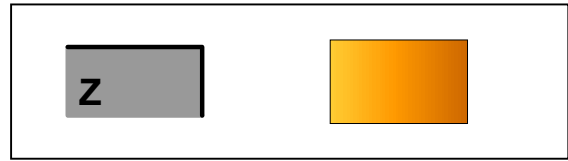

Profilo / Shape	Z h.35	Codice	Tipo	Grana	Gr.	Gr.	Mr.	Mr+Gr	Eng.
Lastra / Slab	20-30	Code	Type	Grit	4D+2A	3D+3A	3D+3A	4D+3A	4D+3DF
Altezza / Haight	35								
Dm / mD	60	ASS14505	SEG	P1	G	G		G	E
DE / oD		ASF14520	FC	P3	G	G		M+G	E
Foro / Bore av.	35-30-22	ASF14525	FC	P4	G				E
		ASF14530	FC	P5	G	G		M+G	E
		ASE14540	ELE	E1			M	M	
		ASE14550	ELE	E2			M		
		ASE14560	ELE	E3			M		
Dimensioni / Dimentions:		ASR14570	ABR	220		G	M	G	
		ASR14575	ABR	400	G	G	M	M+G	
Foro / Bore av.	35-30-22	ASR14580	ABR	1000	G	G	M	M+G	
Dm / mD	70	CSD12485	DIAFLEX	800					E
Foro / Bore av.	35-30-22	CSD12486	DIAFLEX	1500					E
		CSD12487	DIAFLEX	3000					E
					<b>0</b>	<b>0</b>	<b>0</b>	<b>0</b>	<b>0</b>

Profilo / Shape	Z h.45	Codice	Tipo	Grana	Gr.	Gr.	Mr.	Mr+Gr	Eng.
Lastra / Slab	20-30-40	Code	Type	Grit	4D+2A	3D+3A	3D+3A	4D+3A	4D+3DF
Altezza / Haight	35								
Dm / mD	60	ASS14605	SEG	P1	G	G		G	E
DE / oD		ASF14620	FC	P3	G	G		M+G	E
Foro / Bore av.	35-30-22	ASF14625	FC	P4	G				E
		ASF14630	FC	P5	G	G		M+G	E
		ASE14640	ELE	E1			M	M	
		ASE14650	ELE	E2			M		
		ASE14660	ELE	E3			M		
Dimensioni / Dimentions:		ASR14670	ABR	220		G	M	G	
		ASR14675	ABR	400	G	G	M	M+G	
Foro / Bore av.	35-30-22	ASR14680	ABR	1000	G	G	M	M+G	
Dm / mD	70	CSD12525	DIAFLEX	800					E
Foro / Bore av.	30-35-22	CSD12526	DIAFLEX	1500					E
		CSD12527	DIAFLEX	3000					E
					<b>0</b>	<b>0</b>	<b>0</b>	<b>0</b>	<b>0</b>

Profilo / Shape	Z h.55	Codice	Tipo	Grana	Gr.	Gr.	Mr.	Mr+Gr	Eng.
Lastra / Slab	20-30-40-50	Code	Type	Grit	4D+2A	3D+3A	3D+3A	4D+3A	4D+3DF
Altezza / Haight	45								
Dm / mD	60	ASS14705	SEG	P1	G	G		G	E
DE / oD		ASF14720	FC	P3	G	G		M+G	E
Foro / Bore av.	35-30-22	ASF14725	FC	P4	G				E
		ASF14730	FC	P5	G	G		M+G	E
		ASE14740	ELE	E1			M	M	
		ASE14750	ELE	E2			M		
		ASE14760	ELE	E3			M		
Dimensioni / Dimentions:		ASR14770	ABR	220		G	M	G	
		ASR14775	ABR	400	G	G	M	M+G	
Foro / Bore av.	35-30-22	ASR14780	ABR	1000	G	G	M	M+G	
Dm / mD	70	CSD12535	DIAFLEX	800					E
Foro / Bore av.	35-30-22	CSD12536	DIAFLEX	1500					E
		CSD12537	DIAFLEX	3000					E
					<b>0</b>	<b>0</b>	<b>0</b>	<b>0</b>	<b>0</b>

# Mole a profilare CN - Dm60

Profiling wheels for CNC



**N I C O L A I**  
**D I A M A N T**  
diamond tools

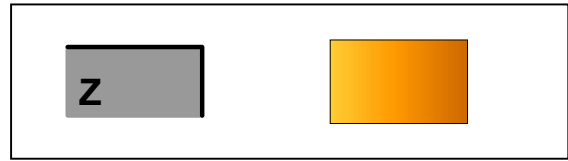

Profilo / Shape	Z h.105	Codice	Tipo	Grana	Gr.	Gr.
Lastra / Slab	100	Code	Type	Grit	4D+3N	4D+3DF
Altezza / Height	105					
Dm / mD	60	ASS18505	SEG	P1	G	G
DE / oD	60	ASF18520	FC	P3	G	G
Foro / Bore av.	35-30-22	ASF18515	FC	P4	G	G
		ASF18530	FC	P5	G	G
Dimensioni / Dimentions:		CSR10046	DIAFACE	800	G	
Nastro / belt:	D80x120	CSR10047	DIAFACE	1500	G	
Foro / Bore av.	35-30-22	CSR10048	DIAFACE	3000	G	
Dimensioni / Dimentions:		CSD12485	DIAFLEX	800		G
	D80x110	CSD12486	DIAFLEX	1500		G
Foro / Bore av.	35-30-22	CSD12487	DIAFLEX	3000		G
Accessori - Accessories		CZZ80012	RULLO ESPANSIONE GOMMA - rubber expanding roller			
		AZC0736A	CONO ISO40-D35x80 - Cone			

# Mole a profilare CN - Dm60

Profiling wheels for CNC



NICOLA I  
DIAMANTI  
diamond tools

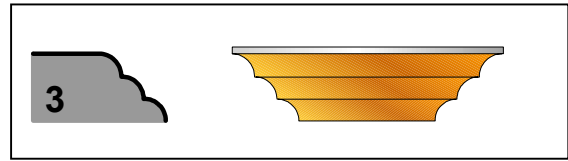

Profilo / Shape	3-20	Codice	Tipo	Grana	Gr.	Gr.	Mr.	Mr+Gr	Eng.
Lastra / Slab	20	Code	Type	Grit	4D+2A	3D+3A	3D+3A	4D+3A	4D+3DF
Raggio / Radius	3								
Dm / mD	60	ASS13905	SEG	P1	G	G		G	
DE / oD	103	ASF13920	FC	P3	G	G		M+G	
Foro / Bore av.	35-30-22	ASF13925	FC	P4	G				
		ASF13930	FC	P5	G	G		M+G	
		ASE13940	ELE	E1			M	M	
		ASE13950	ELE	E2			M		
		ASE13960	ELE	E3			M		
Dimensioni / Dimentions:		ASR13970	ABR	220		G	M	G	
	D125x50	ASR13975	ABR	400	G	G	M	M+G	
Foro / Bore av.	35-30-22	ASR17980	ABR	1000	G	G	M	M+G	
Dm / mD									
Foro / Bore av.									
					0	0	0	0	

Profilo / Shape	3-30	Codice	Tipo	Grana	Gr.	Gr.	Mr.	Mr+Gr	Eng.
Lastra / Slab	30	Code	Type	Grit	4D+2A	3D+3A	3D+3A	4D+3A	4D+3DF
Raggio / Radius	10								
Dm / mD	60	ASS14005	SEG	P1	G	G		G	
DE / oD	125	ASF14020	FC	P3	G	G		M+G	
Foro / Bore av.	35-30-22	ASF14025	FC	P4	G				
		ASF14030	FC	P5	G	G		M+G	
		ASE14040	ELE	E1			M	M	
		ASE14050	ELE	E2			M		
		ASE14060	ELE	E3			M		
Dimensioni / Dimentions:		ASR14074	ABR	220		G	M	G	
	D146x50	ASR14075	ABR	400	G	G	M	M+G	
Foro / Bore av.	35-30-22	ASR14080	ABR	1000	G	G	M	M+G	
Dm / mD									
Foro / Bore av.									
					0	0	0	0	

Profilo / Shape	3-40	Codice	Tipo	Grana	Gr.	Gr.	Mr.	Mr+Gr	Eng.
Lastra / Slab	40	Code	Type	Grit	4D+2A	3D+3A	3D+3A	4D+3A	4D+3DF
Raggio / Radius	13								
Dm / mD	60	ASS14105	SEG	P1	G	G		G	
DE / oD	140	ASF14120	FC	P3	G	G		M+G	
Foro / Bore av.	35-30-22	ASF14125	FC	P4	G				
		ASF14130	FC	P5	G	G		M+G	
		ASE14140	ELE	E1			M	M	
		ASE14150	ELE	E2			M		
		ASE14160	ELE	E3			M		
Dimensioni / Dimentions:		ASR14174	ABR	220		G	M	G	
	D138x60	ASR14175	ABR	400	G	G	M	M+G	
Foro / Bore av.	35-30-22	ASR14180	ABR	1000	G	G	M	M+G	
Dm / mD									
Foro / Bore av.									
					0	0	0	0	

# Mole a profilare CN - Dm60

Profiling wheels for CNC



**N I C O L A I**  
**D I A M A N T**  
diamond tools

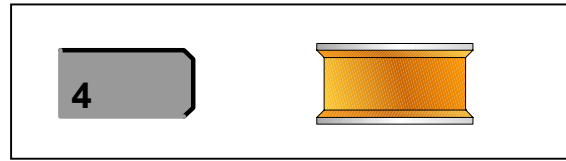

Profilo / Shape	4-20	Codice	Tipo	Grana	Gr.	Gr.	Mr.	Mr+Gr	Eng.
Lastra / Slab	20	Code	Type	Grit	4D+2A	3D+3A	3D+3A	4D+3A	4D+3DF
Piano / Flat	15								
Dm / mD	60	ASS14205	SEG	P1	G	G		G	E
DE / oD	68	ASF14220	FC	P3	G	G		M+G	E
Foro / Bore av.	35-30-22	ASF14225	FC	P4	G				E
		ASF14230	FC	P5	G	G		M+G	E
		ASE14240	ELE	E1			M	M	
		ASE14250	ELE	E2			M		
		ASE14260	ELE	E3			M		
Dimensioni / Dimentions:		ASR14274	ABR	220		G	M	G	
	D98x50	ASR14275	ABR	400	G	G	M	M+G	
Foro / Bore av.	35-30-22	ASR14280	ABR	1000	G	G	M	M+G	
Dm / mD	70	CSD12555	DIAFLEX	800					E
Foro / Bore av.	35-30-22	CSD12556	DIAFLEX	1500					E
		CSD12557	DIAFLEX	3000					E
					0	0	0	0	0

Profilo / Shape	4-30	Codice	Tipo	Grana	Gr.	Gr.	Mr.	Mr+Gr	Eng.
Lastra / Slab	30	Code	Type	Grit	4D+2A	3D+3A	3D+3A	4D+3A	4D+3DF
Piano / Flat	25								
Dm / mD	60	ASS14305	SEG	P1	G	G		G	E
DE / oD	68	ASF14320	FC	P3	G	G		M+G	E
Foro / Bore av.	35-30-22	ASF14325	FC	P4	G				E
		ASF14330	FC	P5	G	G		M+G	E
		ASE14340	ELE	E1			M	M	
		ASE14350	ELE	E2			M		
		ASE14360	ELE	E3			M		
Dimensioni / Dimentions:		ASR14374	ABR	220		G	M	G	
	D98x50	ASR14375	ABR	400	G	G	M	M+G	
Foro / Bore av.	35-30-22	ASR14380	ABR	1000	G	G	M	M+G	
Dm / mD	70	CSD12565	DIAFLEX	800					E
Foro / Bore av.	35-30-22	CSD12566	DIAFLEX	1500					E
		CSD12567	DIAFLEX	3000					E
					0	0	0	0	0

Profilo / Shape	4-40	Codice	Tipo	Grana	Gr.	Gr.	Mr.	Mr+Gr	Eng.
Lastra / Slab	40	Code	Type	Grit	4D+2A	3D+3A	3D+3A	4D+3A	4D+3DF
Piano / Flat	35								
Dm / mD	60	ASS14405	SEG	P1	G	G		G	E
DE / oD	68	ASF14420	FC	P3	G	G		M+G	E
Foro / Bore av.	35-30-22	ASF14425	FC	P4	G				E
		ASF14430	FC	P5	G	G		M+G	E
		ASE14440	ELE	E1			M	M	
		ASE14450	ELE	E2			M		
		ASE14460	ELE	E3			M		
Dimensioni / Dimentions:		ASR14474	ABR	220		G	M	G	
	D118x60	ASR14475	ABR	400	G	G	M	M+G	
Foro / Bore av.	35-30-22	ASR14480	ABR	1000	G	G	M	M+G	
Dm / mD	70	CSD12575	DIAFLEX	800					E
Foro / Bore av.	35-30-22	CSD12576	DIAFLEX	1500					E
		CSD12577	DIAFLEX	3000					E
					0	0	0	0	0

# Mole a profilare CN - Dm35

Profiling wheels for CNC



**N I C O L A I**  
**D I A M A N T**  
diamond tools

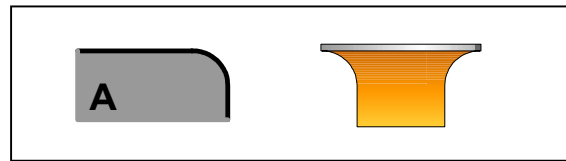

Profilo / Shape	A20	Codice	Tipo	Grana	Gr.	Gr.	Mr.	Mr+Gr	Eng.
Lastra / Slab	20	Code	Type	Grit	4D+2A	3D+3A	3D+3A	4D+3A	4D+3DF
Raggio / Radius	10								
Dm / mD	35	ASS20005	SEG	P1	G	G		G	E
DE / oD	55	ASF20020	FC	P3	G	G		M+G	E
Foro / Bore av.	22-20	ASF20025	FC	P4	G				E
		ASF20030	FC	P5	G	G		M+G	E
		ASE20040	ELE	E1			M	M	
		ASE20050	ELE	E2			M		
		ASE20060	ELE	E3			M		
Dimensioni / Diment		60		ABR	220		G	M	G
		40		ABR	400	G	G	M	M+G
Foro / Bore av.				ABR	1000	G	G	M	M+G
Dm / mD	60			DIAFLEX	800				E
Foro / Bore av.	40			DIAFLEX	1500				E
	22-20			DIAFLEX	3000				E
					0	0	0	0	

Profilo / Shape	A30	Codice	Tipo	Grana	Gr.	Gr.	Mr.	Mr+Gr	Eng.
Lastra / Slab	30	Code	Type	Grit	4D+2A	3D+3A	3D+3A	4D+3A	4D+3DF
Raggio / Radius	15								
Dm / mD	35	ASS20105	SEG	P1	G	G		G	E
DE / oD	65	ASF20120	FC	P3	G	G		M+G	E
Foro / Bore av.	22-20	ASF20125	FC	P4	G				E
		ASF20130	FC	P5	G	G		M+G	E
		ASE20140	ELE	E1			M	M	
		ASE20150	ELE	E2			M		
		ASE20160	ELE	E3			M		
Dimensioni / Diment		70		ABR	220		G	M	G
		40		ABR	400	G	G	M	M+G
Foro / Bore av.				ABR	1000	G	G	M	M+G
Dm / mD	70			DIAFLEX	800				E
Foro / Bore av.	40			DIAFLEX	1500				E
	22-20			DIAFLEX	3000				E
					0	0	0	0	

Profilo / Shape	A40	Codice	Tipo	Grana	Gr.	Gr.	Mr.	Mr+Gr	Eng.
Lastra / Slab	40	Code	Type	Grit	4D+2A	3D+3A	3D+3A	4D+3A	4D+3DF
Raggio / Radius	20								
Dm / mD	35	ASS20205	SEG	P1	G	G		G	E
DE / oD	75	ASF20220	FC	P3	G	G		M+G	E
Foro / Bore av.	22-20	ASF20225	FC	P4	G				E
		ASF20230	FC	P5	G	G		M+G	E
		ASE20240	ELE	E1			M	M	
		ASE20250	ELE	E2			M		
		ASE20260	ELE	E3			M		
Dimensioni / Diment		80		ABR	220		G	M	G
		40		ABR	400	G	G	M	M+G
Foro / Bore av.				ABR	1000	G	G	M	M+G
Dm / mD	80			DIAFLEX	800				E
Foro / Bore av.	40			DIAFLEX	1500				E
	22-20			DIAFLEX	3000				E
					0	0	0	0	

# Mole a profilare CN - Dm35

Profiling wheels for CNC



**N I C O L A I**  
**D I A M A N T**  
diamond tools

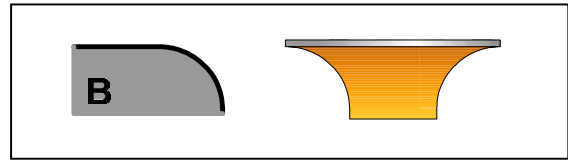

Profilo / Shape		<b>B20</b>							
Lastra / Slab	20	Codice	Tipo	Grana	Gr.	Gr.	Mr.	Mr+Gr	Eng.
Raggio / Radius	20	Code	Type	Grit	4D+2A	3D+3A	3D+3A	4D+3A	4D+3DF
Dm / mD	35	ASS20305	SEG	P1	G	G		G	E
DE / oD	75	ASF20320	FC	P3	G	G		M+G	E
Foro / Bore av.	22-20	ASF20325	FC	P4	G				E
		ASF20330	FC	P5	G	G		M+G	E
		ASE20340	ELE	E1			M	M	
		ASE20350	ELE	E2			M		
		ASE20360	ELE	E3			M		
Dimensioni / Diment	80		ABR	220		G	M	G	
	40		ABR	400	G	G	M	M+G	
Foro / Bore av.			ABR	1000	G	G	M	M+G	
Dm / mD	80		DIAFLEX	800					E
Foro / Bore av.	40		DIAFLEX	1500					E
	22-20		DIAFLEX	3000					E
					<b>0</b>	<b>0</b>	<b>0</b>	<b>0</b>	

Profilo / Shape		<b>B30</b>							
Lastra / Slab	30	Codice	Tipo	Grana	Gr.	Gr.	Mr.	Mr+Gr	Eng.
Raggio / Radius	30	Code	Type	Grit	4D+2A	3D+3A	3D+3A	4D+3A	4D+3DF
Dm / mD	35	ASS20405	SEG	P1	G	G		G	E
DE / oD	95	ASF20420	FC	P3	G	G		M+G	E
Foro / Bore av.	22-20	ASF20425	FC	P4	G				E
		ASF20430	FC	P5	G	G		M+G	E
		ASE20440	ELE	E1			M	M	
		ASE20450	ELE	E2			M		
		ASE20460	ELE	E3			M		
Dimensioni / Diment	100		ABR	220		G	M	G	
	40		ABR	400	G	G	M	M+G	
Foro / Bore av.			ABR	1000	G	G	M	M+G	
Dm / mD	100		DIAFLEX	800					E
Foro / Bore av.	40		DIAFLEX	1500					E
	22-20		DIAFLEX	3000					E
					<b>0</b>	<b>0</b>	<b>0</b>	<b>0</b>	

Profilo / Shape		<b>B40</b>							
Lastra / Slab	40	Codice	Tipo	Grana	Gr.	Gr.	Mr.	Mr+Gr	Eng.
Raggio / Radius	40	Code	Type	Grit	4D+2A	3D+3A	3D+3A	4D+3A	4D+3DF
Dm / mD	35	ASS20505	SEG	P1	G	G		G	E
DE / oD	55	ASF20520	FC	P3	G	G		M+G	E
Foro / Bore av.	22-20	ASF20525	FC	P4	G				E
		ASF20530	FC	P5	G	G		M+G	E
		ASE20540	ELE	E1			M	M	
		ASE20550	ELE	E2			M		
		ASE20560	ELE	E3			M		
Dimensioni / Diment	60		ABR	220		G	M	G	
	40		ABR	400	G	G	M	M+G	
Foro / Bore av.			ABR	1000	G	G	M	M+G	
Dm / mD	60		DIAFLEX	800					E
Foro / Bore av.	40		DIAFLEX	1500					E
	22-20		DIAFLEX	3000					E
					<b>0</b>	<b>0</b>	<b>0</b>	<b>0</b>	

# Mole a profilare CN - Dm35

Profiling wheels for CNC



N I C O L A I  
D I A M A N T  
diamond tools

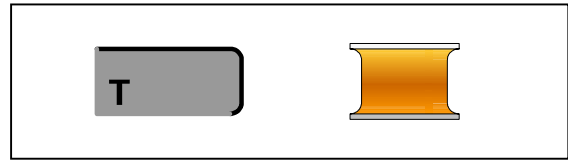

Profilo / Shape		<b>T20</b>		<b>Codice</b>	<b>Tipo</b>	<b>Grana</b>	<b>Gr.</b>	<b>Gr.</b>	<b>Mr.</b>	<b>Mr+Gr</b>	<b>Eng.</b>
Lastra / Slab		20		<b>Code</b>	<b>Type</b>	<b>Grit</b>	<b>4D+2A</b>	<b>3D+3A</b>	<b>3D+3A</b>	<b>4D+3A</b>	<b>4D+3DF</b>
Raggio / Radius		3									
Dm / mD	35	ASS22705	SEG	P1	G	G				G	E
DE / oD	50	ASF22720	FC	P3	G	G				M+G	E
Foro / Bore av.	22-20	ASF22725	FC	P4	G						E
		ASF22730	FC	P5	G	G				M+G	E
		ASE22740	ELE	E1					M	M	
		ASE22750	ELE	E2					M		
		ASE22760	ELE	E3					M		
Dimensioni / Dimentions:				ABR	220			G	M	G	
40				ABR	400		G	G	M	M+G	
Foro / Bore av.				ABR	1000		G	G	M	M+G	
Dm / mD				DIAFLEX	800						E
Foro / Bore av.	40			DIAFLEX	1500						E
				DIAFLEX	3000						E
							0	0	0	0	

Profilo / Shape		<b>T30</b>		<b>Codice</b>	<b>Tipo</b>	<b>Grana</b>	<b>Gr.</b>	<b>Gr.</b>	<b>Mr.</b>	<b>Mr+Gr</b>	<b>Eng.</b>
Lastra / Slab		30		<b>Code</b>	<b>Type</b>	<b>Grit</b>	<b>4D+2A</b>	<b>3D+3A</b>	<b>3D+3A</b>	<b>4D+3A</b>	<b>4D+3DF</b>
Raggio / Radius		5									
Dm / mD	35	ASS22805	SEG	P1	G	G				G	E
DE / oD	50	ASF22820	FC	P3	G	G				M+G	E
Foro / Bore av.	22-20	ASF22825	FC	P4	G						E
		ASF22830	FC	P5	G	G				M+G	E
		ASE22840	ELE	E1					M	M	
		ASE22850	ELE	E2					M		
		ASE22860	ELE	E3					M		
Dimensioni / Dimentions:				ABR	220			G	M	G	
40				ABR	400		G	G	M	M+G	
Foro / Bore av.				ABR	1000		G	G	M	M+G	
Dm / mD				DIAFLEX	800						E
Foro / Bore av.	40			DIAFLEX	1500						E
				DIAFLEX	3000						E
							0	0	0	0	

Profilo / Shape		<b>T40</b>		<b>Codice</b>	<b>Tipo</b>	<b>Grana</b>	<b>Gr.</b>	<b>Gr.</b>	<b>Mr.</b>	<b>Mr+Gr</b>	<b>Eng.</b>
Lastra / Slab		40		<b>Code</b>	<b>Type</b>	<b>Grit</b>	<b>4D+2A</b>	<b>3D+3A</b>	<b>3D+3A</b>	<b>4D+3A</b>	<b>4D+3DF</b>
Raggio / Radius		5									
Dm / mD	35	ASS22905	SEG	P1	G	G				G	E
DE / oD	50	ASF22920	FC	P3	G	G				M+G	E
Foro / Bore av.	22-20	ASF22925	FC	P4	G						E
		ASF22930	FC	P5	G	G				M+G	E
		ASE22940	ELE	E1					M	M	
		ASE22950	ELE	E2					M		
		ASE22960	ELE	E3					M		
Dimensioni / Dimentions:				ABR	220			G	M	G	
40				ABR	400		G	G	M	M+G	
Foro / Bore av.				ABR	1000		G	G	M	M+G	
Dm / mD				DIAFLEX	800						E
Foro / Bore av.	40			DIAFLEX	1500						E
				DIAFLEX	3000						E
							0	0	0	0	

# Mole a profilare CN - Dm35

Profiling wheels for CNC



**N I C O L A I**  
**D I A M A N T**  
diamond tools

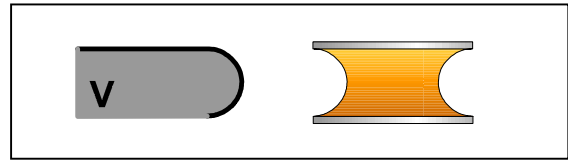

Profilo / Shape		<b>V20</b>		<b>Codice</b>	<b>Tipo</b>	<b>Grana</b>	<b>Gr.</b>	<b>Gr.</b>	<b>Mr.</b>	<b>Mr+Gr</b>	<b>Eng.</b>
Lastra / Slab		20		<b>Code</b>	<b>Type</b>	<b>Grit</b>	<b>4D+2A</b>	<b>3D+3A</b>	<b>3D+3A</b>	<b>4D+3A</b>	<b>4D+3DF</b>
Raggio / Radius		10									
Dm / mD	35	ASS23005	SEG	P1	G	G				G	E
DE / oD	55	ASF23020	FC	P3	G	G				M+G	E
Foro / Bore av.	22-20	ASF23025	FC	P4	G						E
		ASF23030	FC	P5	G	G				M+G	E
		ASE23040	ELE	E1					M	M	
		ASE23050	ELE	E2					M		
		ASE23060	ELE	E3					M		
Dimensioni / Dimentions:			ABR	220				G	M	G	
	40		ABR	400	G	G		M	M	M+G	
Foro / Bore av.			ABR	1000	G	G		M	M	M+G	
Dm / mD			DIAFLEX	800							E
Foro / Bore av.	40		DIAFLEX	1500							E
		22-20		DIAFLEX	3000						E

Profilo / Shape		<b>V30</b>		<b>Codice</b>	<b>Tipo</b>	<b>Grana</b>	<b>Gr.</b>	<b>Gr.</b>	<b>Mr.</b>	<b>Mr+Gr</b>	<b>Eng.</b>
Lastra / Slab		30		<b>Code</b>	<b>Type</b>	<b>Grit</b>	<b>4D+2A</b>	<b>3D+3A</b>	<b>3D+3A</b>	<b>4D+3A</b>	<b>4D+3DF</b>
Raggio / Radius		15									
Dm / mD	35	ASS23105	SEG	P1	G	G				G	E
DE / oD	65	ASF23120	FC	P3	G	G				M+G	E
Foro / Bore av.	22-20	ASF23125	FC	P4	G						E
		ASF23130	FC	P5	G	G				M+G	E
		ASE23140	ELE	E1					M	M	
		ASE23150	ELE	E2					M		
		ASE23160	ELE	E3					M		
Dimensioni / Dimentions:			ABR	220				G	M	G	
	40		ABR	400	G	G		M	M	M+G	
Foro / Bore av.			ABR	1000	G	G		M	M	M+G	
Dm / mD			DIAFLEX	800							E
Foro / Bore av.	40		DIAFLEX	1500							E
		22-20		DIAFLEX	3000						E

Profilo / Shape		<b>4-40</b>		<b>Codice</b>	<b>Tipo</b>	<b>Grana</b>	<b>Gr.</b>	<b>Gr.</b>	<b>Mr.</b>	<b>Mr+Gr</b>	<b>Eng.</b>
Lastra / Slab		40		<b>Code</b>	<b>Type</b>	<b>Grit</b>	<b>4D+2A</b>	<b>3D+3A</b>	<b>3D+3A</b>	<b>4D+3A</b>	<b>4D+3DF</b>
Raggio / Radius		20									
Dm / mD	35	ASS23205	SEG	P1	G	G				G	E
DE / oD	75	ASF23220	FC	P3	G	G				M+G	E
Foro / Bore av.	22-20	ASF23225	FC	P4	G						E
		ASF23230	FC	P5	G	G				M+G	E
		ASE23240	ELE	E1					M	M	
		ASE23250	ELE	E2					M		
		ASE23260	ELE	E3					M		
Dimensioni / Dimentions:			ABR	220				G	M	G	
	40		ABR	400	G	G		M	M	M+G	
Foro / Bore av.			ABR	1000	G	G		M	M	M+G	
Dm / mD			DIAFLEX	800							E
Foro / Bore av.	40		DIAFLEX	1500							E
		22-20		DIAFLEX	3000						E

# Mole a profilare CN - Dm35

Profiling wheels for CNC



**N I C O L A I**  
D I A M A N T  
diamond tools

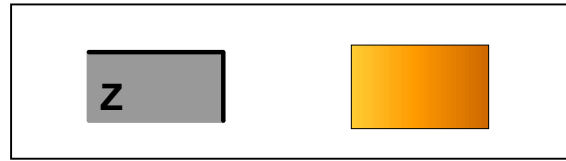

Profilo / Shape		Z h.35		Codice	Tipo	Grana	Gr.	Gr.	Mr.	Mr+Gr	Eng.
Lastra / Slab		20-30		Code	Type	Grit	4D+2A	3D+3A	3D+3A	4D+3A	4D+3DF
Raggio / Radius											
Dm / mD	35			SEG	P1		G	G		G	E
DE / oD	35			FC	P3		G	G		M+G	E
Foro / Bore av.	22-20			FC	P4		G				E
				FC	P5		G	G		M+G	E
				ELE	E1				M	M	
				ELE	E2				M		
				ELE	E3				M		
Dimensioni / Dimentions:				ABR	220					G	
	40			ABR	400		G	G	M	M+G	
Foro / Bore av.				ABR	1000		G	G	M	M+G	
Dm / mD				DIAFLEX	800						E
Foro / Bore av.				DIAFLEX	1500						E
				DIAFLEX	3000						E
							0	0	0	0	

Profilo / Shape		Z h.45		Codice	Tipo	Grana	Gr.	Gr.	Mr.	Mr+Gr	Eng.
Lastra / Slab		30-40		Code	Type	Grit	4D+2A	3D+3A	3D+3A	4D+3A	4D+3DF
Raggio / Radius											
Dm / mD	35			SEG	P1		G	G		G	E
DE / oD	35			FC	P3		G	G		M+G	E
Foro / Bore av.	22-20			FC	P4		G				E
				FC	P5		G	G		M+G	E
				ELE	E1				M	M	
				ELE	E2				M		
				ELE	E3				M		
Dimensioni / Dimentions:				ABR	220			G	M	G	
	40			ABR	400		G	G	M	M+G	
Foro / Bore av.				ABR	1000		G	G	M	M+G	
Dm / mD				DIAFLEX	800						E
Foro / Bore av.	40			DIAFLEX	1500						E
				DIAFLEX	3000						E
	22-20						0	0	0	0	

Profilo / Shape		Z h.55		Codice	Tipo	Grana	Gr.	Gr.	Mr.	Mr+Gr	Eng.
Lastra / Slab		40-50		Code	Type	Grit	4D+2A	3D+3A	3D+3A	4D+3A	4D+3DF
Raggio / Radius											
Dm / mD	35			SEG	P1		G	G		G	E
DE / oD	35			FC	P3		G	G		M+G	E
Foro / Bore av.	22-20			FC	P4		G				E
				FC	P5		G	G		M+G	E
				ELE	E1				M	M	
				ELE	E2				M		
				ELE	E3				M		
Dimensioni / Dimentions:				ABR	220			G	M	G	
	40			ABR	400		G	G	M	M+G	
Foro / Bore av.				ABR	1000		G	G	M	M+G	
Dm / mD				DIAFLEX	800						E
Foro / Bore av.	40			DIAFLEX	1500						E
				DIAFLEX	3000						E
	22-20						0	0	0	0	

# Mole a profilare CN - Dm35

Profiling wheels for CNC



N I C O L A I  
D I A M A N T  
diamond tools

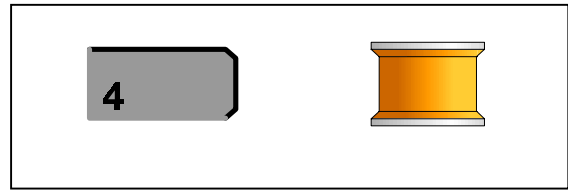

Profilo / Shape		4-20									
Lastra / Slab		20		Codice	Tipo	Grana	Gr.	Gr.	Mr.	Mr+Gr	Eng.
				Code	Type	Grit	4D+2A	3D+3A	3D+3A	4D+3A	4D+3DF
Dm / mD	35	ASS24205	SEG	P1	G	G				G	E
DE / oD		ASF24220	FC	P3	G	G				M+G	E
Foro / Bore av.	22-20	ASF24225	FC	P4	G						E
		ASF24230	FC	P5	G	G				M+G	E
		ASE24240	ELE	E1					M	M	
		ASE24250	ELE	E2					M		
		ASE24260	ELE	E3					M		
Dimensioni / Dimentions:				ABR	220			G	M	G	
40				ABR	400		G	G	M	M+G	
Foro / Bore av.				ABR	1000		G	G	M	M+G	
Dm / mD				DIAFLEX	800						E
Foro / Bore av.		40		DIAFLEX	1500						E
22-20				DIAFLEX	3000						E

Profilo / Shape		4-30									
Lastra / Slab		30		Codice	Tipo	Grana	Gr.	Gr.	Mr.	Mr+Gr	Eng.
				Code	Type	Grit	4D+2A	3D+3A	3D+3A	4D+3A	4D+3DF
Dm / mD	35	ASS24305	SEG	P1	G	G				G	E
DE / oD		ASF24320	FC	P3	G	G				M+G	E
Foro / Bore av.	22-20	ASF24325	FC	P4	G						E
		ASF24330	FC	P5	G	G				M+G	E
		ASE24340	ELE	E1					M	M	
		ASE24350	ELE	E2					M		
		ASE24360	ELE	E3					M		
Dimensioni / Dimentions:				ABR	220			G	M	G	
40				ABR	400		G	G	M	M+G	
Foro / Bore av.				ABR	1000		G	G	M	M+G	
Dm / mD				DIAFLEX	800						E
Foro / Bore av.		40		DIAFLEX	1500						E
22-20				DIAFLEX	3000						E

Profilo / Shape		4-40									
Lastra / Slab		40		Codice	Tipo	Grana	Gr.	Gr.	Mr.	Mr+Gr	Eng.
				Code	Type	Grit	4D+2A	3D+3A	3D+3A	4D+3A	4D+3DF
Dm / mD	35	ASS24405	SEG	P1	G	G				G	E
DE / oD		ASF24420	FC	P3	G	G				M+G	E
Foro / Bore av.	22-20	ASF24425	FC	P4	G						E
		ASF24430	FC	P5	G	G				M+G	E
		ASE24440	ELE	E1					M	M	
		ASE24450	ELE	E2					M		
		ASE24460	ELE	E3					M		
Dimensioni / Dimentions:				ABR	220			G	M	G	
40				ABR	400		G	G	M	M+G	
Foro / Bore av.				ABR	1000		G	G	M	M+G	
Dm / mD				DIAFLEX	800						E
Foro / Bore av.		40		DIAFLEX	1500						E
22-20				DIAFLEX	3000						E